

Best practice guidelines for holistic open space turf management in Sydney



First published in Australia in 2011 by Sydney Water
1 Smith St
Parramatta NSW 2150
Australia
sydneywater.com.au

Copyright © 2011 in text and photographs (except where otherwise credited below)
Copyright © 2011 Sydney Water Corporation

All rights reserved. No part of this publication may be reproduced, stored in a retrieval system or transmitted, in any form or by any means, electronic, mechanical, photocopying, recording or otherwise, without the prior written permission of the publishers and copyright holders.

Disclaimer

Occasional references in this publication to trade names and proprietary products are inevitable, but such references are not to be construed as constituting an endorsement of the named products, nor is any criticism implied of similar products that are not mentioned. The points of view expressed are those of the authors and do not necessarily reflect the official policies of Sydney Water. The information provided by the authors is given in good faith and based on their knowledge and experience. It cannot, however, be expected to cover all contingencies that might arise in actual practice. The guidelines are published without liability on the part of the authors or Sydney Water for any loss or damage suffered as a result of their application or use.

Message from the Managing Director

The *Best practice guidelines for holistic open space turf management in Sydney* promote the efficient use of water on Sydney sports fields. These guidelines are just one of a series of documents compiled by Sydney Water to help save our precious water supply. This series aims to capture the expertise of Sydney Water and key industry experts to share 'best practice' industry knowledge.

Within Sydney Water's area of operations, there is an abundance of open space turf areas for active and passive recreation. However, there are also dramatic contrasts in altitude, landform, soil type, climate, population density and land use.

All open space turf areas require maintenance to meet quality, fit-for-purpose and sustainability requirements. Irrigating open space turf areas accounts for over half of the water used by councils in Sydney Water's area of operations. This irrigation uses about 8 million litres of water a day.

But managing these areas is not just about water. Far too often, people misunderstand the need for resources, for example:

- over-watering on sites that need more fertiliser
- installing expensive drainage systems on sites that actually need soil decompaction
- decompacting sandy sites
- adding too many nutrients to sites with thin topsoil.

The industry widely acknowledges the need to develop a common understanding on effective open space management to meet community needs and minimise resource use. These best practice guidelines will help you understand the needs of soil, turfgrass and how water is used, but they will also help you understand the relationship between these factors. It aims to supply turf managers with the tools to develop the best strategies to balance turf health with the needs of those using the open space.

While some of the information here may challenge some widely accepted practices, we believe this will open up new opportunities to increase the quality of sports fields and save water at the same time. We welcome the discussion.

We hope the best practice guidelines encourage open space turf managers to think holistically about their sports fields, appreciating the relationship between soil, turf, irrigation, drainage, patronage and management practices.

Kevin Young
Managing Director, Sydney Water



Kevin Young
Managing Director

Acknowledgements

These guidelines will be reviewed and updated with new technical information as it becomes available. Comments on the guidelines can be emailed to businesscustomerservices@sydneywater.com.au. The names of government departments and agencies mentioned in these guidelines were correct at the time of publication.

Sydney Water thanks the following for their contribution to these best practice guidelines:

Technical advisors

- Dr Peter Martin – University of Sydney (Principal advisor)
- Dr Mick Battam, AgEnviro Solutions, Pty Ltd (Principal advisor)
- Geoff Hatton, Sustainable Turf Renovations
- Steve Garland, Steve Garland Landscapes Pty Ltd
- Dr Jim Hull, Independent Turfgrass Consulting Pty Ltd
- Simon Leake, Sydney Environmental Soil Laboratories Pty Ltd
- Tim Gilbert, Irrigation Australia Ltd
- Tony Spinks, Hydroplan Pty Ltd
- Rohan Brown, Hydroplan Pty Ltd
- Annie Kavanagh, Department of Environment, Climate Change and Water
- Assoc Prof Basant Maheshwari, University of Western Sydney

Acknowledgements

- Claire Hammond, formerly Sydney Water
- David McKechnie, Irrigation and turf consultant
- Alisa Bryce, URS Pty Ltd
- Joshua Ryan, URS Pty Ltd
- Craig Briscoe, Cronulla Golf Club
- Alexia Hill, Wingecarribee Shire Council
- Mark Bowman, Department of Defence
- Bruce Sutton, University of Sydney
- Andrew Porter, URS Pty Ltd
- Stuart Sutton, Ezi-grow Pty Ltd
- Tony Hodgins, Department of Environment, Climate Change and Water

Peer review (in alphabetical order)

- Phillip Ambler, Ku-ring-gai Council
- Sally Armstrong, Sydney Water
- Darren Atkins, Sydney Water
- Ian Curtis, Hurstville City Council
- Mark Goddard, Blue Mountains City Council
- Fernando Ortega, Sydney Water
- Tony Robinson, Sydney Water
- Melanie Schwecke, Pittwater Council
- Alison Scotland, Sydney Water
- Grant Willoughby, Sutherland Shire Council

Contents

Message from the Managing Director	1
Acknowledgements	2
Contents	3
List of figures	5
List of tables	6
Introduction	7
Get the basics right	7
Why is open space turf management important?	7
Case study: Kings Park, Parramatta	8
Benefits of open space turf areas	8
How are open space turf areas classified?	9
Part 1 – Soil	10
What is soil?	12
What kinds of soils do we have in Sydney sports fields?	12
How much water can different soil textures hold?	15
Your topsoil is your water tank	15
Managing soil compaction	18
Case study: Layering and compaction at an oval in Sylvania	22
Case study: Surface hardness and infiltration at an oval in Narellan	23
Water repellent soils	24
Case study: Using organics at Wingecarribee Shire Council ¹⁹	24
Other soil issues to look out for	25
Part2 – Turf	28
The relationship between turf, soil and water	30
How much water does turf need?	32
Watering open space turf areas in Sydney	32
Microclimates	33
Case study: Trees competing with turf on Paul Keating Park, Bankstown	37
Good nutrition leads to healthy turf	38
Understanding nutrient requirements	41
Managing insects, weeds and diseases	43
Managing turf thatch	47
Replacing turf	48

Part 3 – Irrigation and drainage	51
Irrigating turf	52
Case study: Working out the irrigation system efficiency for a soccer field	53
Irrigation system design	54
Maintaining irrigation systems	56
When should I water, and how often?	58
Dealing with excess water	60
Promoting run-off	61
Case study – Waterlogging at Birchgrove Oval	63
Part 4 – Holistic management	65
The key to healthy turf	66
Managing increased foot and vehicle traffic	66
Monitoring water use	66
Central control systems	71
Other ways to estimate irrigation demand	74
Alternative water sources	75
Where to find a qualified consultant	76
Learn more – other resources for sports field management	76
Appendix	79
Appendix A Weeds commonly found in Sydney open space turf areas and their major growth periods.	80
Appendix B Pests commonly found damaging turf in the Sydney region and their season of greatest impact.	82
Appendix C Common diseases in the Sydney region and their season of greatest impact	83
Appendix D Existing standards and guidelines for irrigation system design	84
Appendix E Checklist	85
Appendix F Glossary	95
Appendix G Bibliography	100

List of figures

Figure 1	Open space turf areas provide important social and environmental benefits	8
Figure 2	The soil texture triangle	12
Figure 3	Relative size of sand, silt and clay particles in soil	13
Figure 4	The effect of topsoil depth on turfgrass performance for lawns that receive low levels of traffic	14
Figure 5	The type of your topsoil relates to the size of a water tank	15
Figure 6	Three important moisture levels of soil	16
Figure 7	Readily available water	16
Figure 8	The influence of waterlogging on compaction caused by foot traffic	18
Figure 9	Soil layering caused by top-dressing with too sandy a soil mix	19
Figure 10	Soils with added compost conditioner showed more resistance to compaction	23
Figure 11	Effect of incorporating compost into the Government Road sports field	24
Figure 12	Water repellent sand.	25
Figure 13	Comparative growth rates of couch, kikuyu, buffalo and ryegrass at a sports field in Five Dock	30
Figure 14	Turf that has reached PWP	33
Figure 15	Good coverage on a rain-fed sports field one week after the end of February 2009 dry spell	33
Figure 16	Turf and non-turf options for heavily shaded areas	35
Figure 17	It is often difficult to grow turf close to large trees	36
Figure 18	Clover is a common weed in Sydney turfgrass	43
Figure 19	Bill bug infestation	44
Figure 20	Be alert to the presence of pests in turf	45
Figure 21	Encourage healthy turf growth to prevent disease	46
Figure 22	Instant turf is quick to establish	49
Figure 23	Densogram for Hunter I21 sprinklers #6 at 550 kPa square spacing.	52
Figure 24	The effect of poor DU on turf performance	53
Figure 25	Irrigation systems must be designed by a professional	55
Figure 26	Irrigation should be used to maintain turf growth and condition	58
Figure 27	Too much water can be as damaging as too little	60
Figure 28	Possible slopes for sports field surfaces	61
Figure 29	Cross section of slit drains	62
Figure 30	Waterlogging problems caused by top-dressing with sand	63
Figure 31	Are traffic loads sustainable?	66
Figure 32	Typical locations to install a submeter on an irrigation system	67
Figure 33	Read your meter as part of your routine maintenance program	68
Figure 34	How to read a standard water meter	68

List of figures (continued)

Figure 35	How to read a large water meter	69
Figure 36	Data loggers can be easily installed and used	70
Figure 37	By attaching a data transmitter to a water meter, you can send data to a website	70
Figure 38	Green patches in turf can indicate a leak in the irrigation system	71
Figure 39	Site water use monitoring profile indicating a base flow	71
Figure 40	An holistic approach is the key to water management	72
Figure 41	Typical automatic weather station	73
Figure 42	A qualified consultant can advise on one or many aspects of turfgrass management	76

List of tables

Table 1	The effect of turf condition on CO ₂ capture and heat transfer	9
Table 2	Different types of Sydney open space areas	9
Table 3	Readily available water (mm/m) for different soil types	17
Table 4	The effect of texture on infiltration rate	17
Table 5	Techniques for soil aeration and decompaction	20
Table 6	Water droplet test for assessing the degree of water repellence	25
Table 7	Other soil problems in Sydney open space turf areas	26
Table 8	Characteristics of turfgrasses used in Sydney	31
Table 9	Minimum hours of full summer sun between 9 am and 5 pm (daylight saving time) required to sustain healthy turfgrass in Sydney	34
Table 10	Recommended mowing heights	36
Table 11	Functions of turf plant nutrients and symptoms of deficiency	39
Table 12	Use of lime, dolomite and gypsum for various soil pH and Ca:Mg scenarios	41
Table 13	Soil pH and turfgrass responses to lime and iron	41
Table 14	Nutrients supplied by organic products	42
Table 15	Renovation techniques to remove excessive turf thatch	48
Table 16	Minimum irrigation performance requirements for open space turf areas	54
Table 17	Best practice selection criteria for irrigation system components	57
Table 18	How to estimate the moisture status of the soil by appearance and feel	59
Table 19	Average climatic conditions in December for the Sydney area	74
Table 20	Alternative water sources for open space turf irrigation	75

Introduction – open space turf management¹

Get the basics right

Successful and efficient open space turf management relies on getting the basics right.

This means having the right soil, the right turf plants, the right irrigation and the right ongoing maintenance schedule. A best practice open space turf area should meet community expectations for access, aesthetics, safety and playability.

These guidelines will help you answer some common turf management questions that focus on 'getting things right', including:

- How deep should my soil be? (Part 1)
- The field is hard. How do I fix it? (Part 1)
- Is my soil any good? How do I improve it? (Part 1)
- How soon can sport commence after rain? (Part 4)
- What fertilisers should be applied? (Part 2)
- The ground is bare under trees. What should I do? (Part 2)
- How do I know if a bug is eating my turf? (Part 2)
- How often should I water? How much water should I be using? (Part 3)
- How can I save water? (Part 3)

- Is my irrigation system using too much water? (Part 3)
- Do I need to install a drainage system? (Part 3)
- Will my field cope if it's used for more sports games? (Part 4)
- How do I become more water efficient? (Part 4).

Why is open space turf management important?

Irrigation of open space turf areas accounts for over half of the water used by local councils. Council reserves and sports fields in Sydney use over eight million litres of water a day for irrigation and can host thousands of games of sport a year.

During the long drought many open space areas in Sydney struggled to survive. Water restrictions aggravated already poor turf conditions, and exposed existing problems with soil and turf management.

Many sports fields are being used for more games on weekdays and weeknights as well as weekends. Wear and tear is affecting the condition of sports fields and ovals. Turf managers need tools to develop the best strategies to balance turf health with the needs of open space users.

Councils and other open space managers are trying to use water, energy and other resources more efficiently, while providing more services to the community.

These guidelines will help you manage open space areas so they can thrive with less water and less costly management practices – while still providing a safe and enjoyable environment for users.

The guidelines cover aspects of open space turf management including soil health, water needs, drainage, turf nutrition and foot traffic. This document also suggests ways to irrigate your fields accurately and efficiently.

Open space turf areas covered by the guidelines include public landscaped areas, playing fields, parks and play areas, which offer opportunities for sport, recreation and aesthetics. The guidelines are suitable for open space managers in councils, schools, universities and sporting clubs.

These open space guidelines **have not** been written for:

- single purpose turf areas such as lawn tennis courts, bowling or croquet greens
- specialised areas such as cricket wickets, golf greens or turf farms
- turf areas used for dog or horse sports (racing, polo and polocrosse).

Although these guidelines are not written to help construct new open space areas, you can use the same principles when doing so.

Figure 1 – Open space turf areas provide important social and environmental benefits



Case study: Kings Park, Parramatta² An example of best practice open space turf management

Kings Park is an example of best practice because it has:

- 300 mm topsoil
- appropriate turf grass for its environment
- a site with a slope of at least 1 in 100
- well-managed foot traffic on-site, and no traffic at all when soils are wet
- sufficient time to recover from wear and tear
- the right amount of water and nutrients.

This means that turf at Kings Park:

- is green and healthy
- is resilient
- needs minimal irrigation and has fewer drainage problems than other sports fields
- costs less to manage because there is no supplementary irrigation.



Benefits of open space turf areas

In urban regions, open space turf areas provide important social and environmental benefits.

Environmental benefits

Open space turf areas provide:

- a durable ground cover that protects soil from erosion
- a space for rainwater to infiltrate instead of adding to stormwater run-off
- a sink to absorb carbon dioxide (CO₂) from the atmosphere (see Table 1)
- a respite from the ‘urban heat island’ (Beard and Green, 1994).

Social benefits

Access to open space turf areas improves the physical and mental health of the community (Maas et al, 2006). Benefits include:

- increased fitness (American College of Sports Medicine, 1990)
- reduced illness – specifically a reduced risk of heart disease (AIHW, 2008) and type II diabetes (Robbins et al, 2007)
- increased life expectancy (Pafffenbarger et al, 1986)
- reduced tension and violence in urban areas (Kuo and Sullivan, 2001)
- improved recovery from depression as a result of better exercise opportunities (Maller et al, 2008).

How are open space turf areas classified?

These guidelines cover four broad types of open space turf areas. These are described in Table 2.



Most open space turf areas must provide a safe, durable surface on which to play sport or a comfortable and attractive site for passive recreation.

The cost of constructing and maintaining different types of turf areas varies greatly, so it is important to match the design and management of the site to its intended purpose.

Part 4 (Holistic turf management) outlines the reasons why fields become stressed and playing surfaces degrade. Heavy traffic and

high intensity use on a field leads to greater wear and tear, and consequently a greater demand for water and nutrients. As an open space manager, you need to manage wear, traffic, turf selection and recovery times to improve the safety and quality of your field.

Table 1 – The effect of turf condition on CO₂ capture and heat transfer³

Turf condition	CO ₂ capture (tonnes/Ha/yr)	Turf temperature on a hot day*
	1 to 2	42 to 45 °C
	5 to 6	37 °C
	6 to 7	32 °C

* based on measurements taken by Dr Mick Battam on three adjacent turf areas on a November day when air temperature exceeded 40°C

Table 2 – Different types of Sydney open space areas covered in the best practice guidelines⁴

Category	Description	Best practice irrigation (ML/Ha/ year)*
Elite	State / national competition, generally associated with stadiums	4 to 9
Regional	State / regional / first grade playing surface	2.5 to 5
Local	Local sports fields	1.5 to 3.5
Passive	Neighbourhood parks, passive reserves, lawn areas	0 to 2.5

* based on warm season turfgrasses

Introduction endnotes

- Contributors: Mick Battam, Peter Martin, Basant Maheshwari, Geoff Hatton
- Andrew Porter and Joshua Ryan
- P Martin and M Battam
- Based on the deficit model developed by Mick Battam and Steve Garland





Part 1

Soil

Contributors: Mick Battam, Peter Martin, Geoff Hatton, Steve Garland, Simon Leake and Basant Maheshwari

What is soil?

Soil is made up of minerals, organic matter, water, air and living organisms. It is the growing medium used on almost all open space turf areas in Sydney. Healthy soil is one of the most important aspects of good turf management. Soil provides the physical support, water and nutrients needed by plants.

The characteristics of the soil in your sports field will affect:

- watering requirements
- root depth and efficiency
- site drainage
- supply of nutrients to turf
- incidence of weeds, pests and diseases.

Current practices in turf management focus on irrigation or fertilising schedules. These are necessary, but irrigation and fertiliser can be minimised if the soil texture is appropriate to the purpose of the open space turf area.

What kinds of soils do we have in Sydney sports fields?

The following soil textures are likely to be found in Sydney sports fields:

- **Sand** – individual sand grains can easily be seen and felt and have no coherence when wet. A sandy soil is less chemically and physically active than a clay soil.
- **Loamy sand** – slightly cohesive when moist.
- **Sandy loam** – many of the individual sand grains can

still be seen and felt, but there is sufficient silt and/or clay to give coherence to the soil, so that a round ball can be formed.

- **Loam** – when worked into a ball, a loam is smooth in the hand and very coherent.
- **Clay** – clays have a high surface area and can have a high amount of chemical and physical activity. Clay will become more plastic when worked in the hand.

Figure 2 – The soil texture triangle⁵

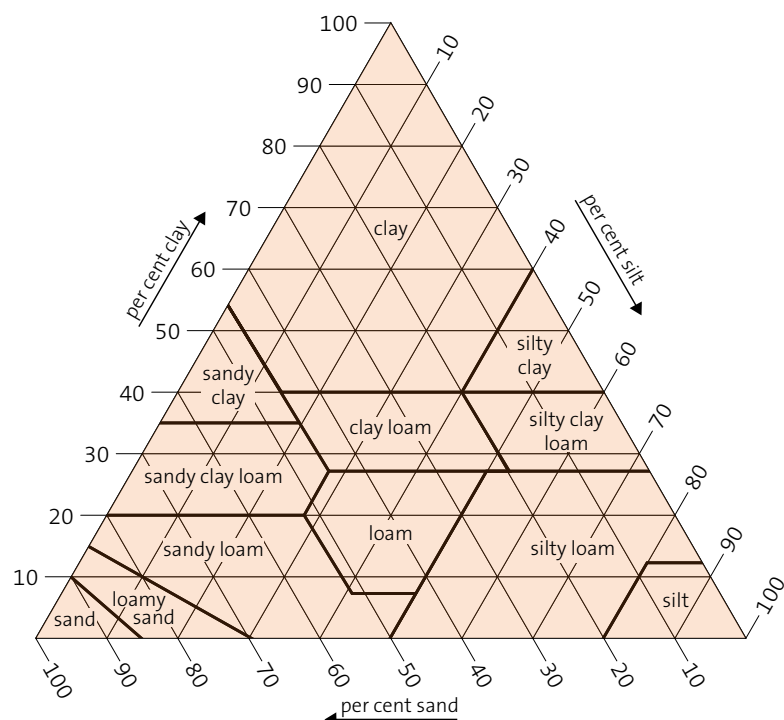
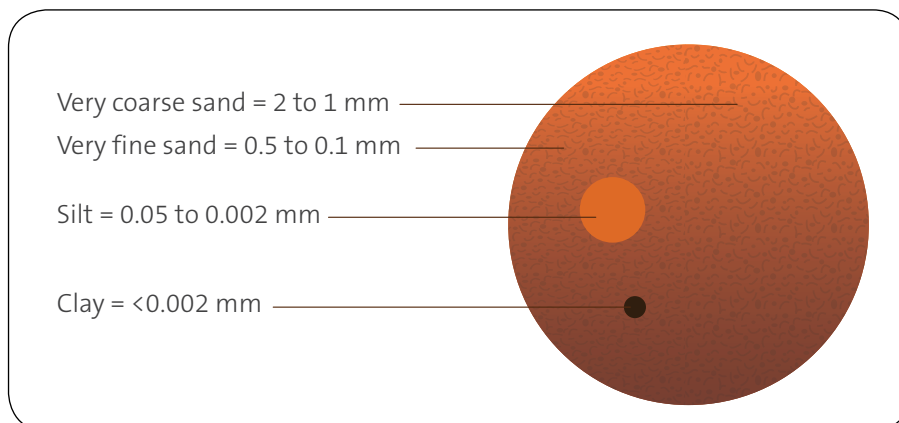

Figure 3 – Relative size of sand, silt and clay particles in soil⁶

Turf can grow well on a range of different soils, but some soils require more management than others. For example, in a local sports field, pure sand would require substantially more attention than a sandy loam.

Sandy soils need careful management

Turf managers love sand because it:

- resists compaction
- returns rapidly to playability after rain
- doesn't turn to mud when wet
- provides a firm surface
- is easy to spread.

However, sandy soils can hold very small amounts of nutrients and water for turf use. This can be overcome by proper field construction and fertiliser practices.

When sandy soil is natural and deep, it can be low in moisture-holding capacity, but the root depth of couch and kikuyu can be deep in these cases.

Turf profiles built on sand should be constructed on an appropriate base, or constructed on a gravel layer. When this is done there is low tension at the bottom of the soil profile, preventing water from draining away. This allows water to perch above the capillary break, holding 450–750 kL/ha of water in 300 mm of root zone.

If you have a deep, draining sand profile, use organic or controlled-release fertilisers, try to build up organic matter in the soil, and irrigate with smaller amounts more frequently to avoid water loss below the root zone.

Silty soils lead to compaction

These soils ultimately set like a brick due to their high silt content, unless they are very frequently irrigated and aerated.

Avoid heavy clays and shales if you can help it

Heavy clays and weathered shale should not be used for turf-growing. They are prone to compaction and waterlogging which leaves little water for turf uptake. If sites are already constructed using heavy clay or weathered shale, an alternative growing medium must be imported and properly laid out.

Check the quality of the soil before purchasing from a supplier. For further information, consult a soil scientist.

Healthy, deep topsoil with a good structure and texture is essential for turf health. Deep topsoils hold more water than shallow soils.

Do not skimp on topsoil depth. Topsoil should be at least 250 mm deep. If you are constructing a new sports field, you should not sign off on completed works if topsoil is any shallower. You may

re-use existing topsoil, or amend existing soil by adding sand to get the required depth at less cost.

Regardless of how good the soil is, turf growing on topsoil less than 170 mm deep will:

- need frequent watering
- be at risk of waterlogging
- be susceptible to compaction
- be more vulnerable to weed infestation.

Turf growing on less than 130 mm of topsoil will struggle to maintain coverage even if the site receives little or no traffic, as shown in Figure 4.

Despite the major influence of soil on site performance, turf is often laid directly on top of shale, clay or even builder's rubble.

Figure 4 – The effect of topsoil depth on turfgrass performance for lawns that receive low levels of traffic⁷



Your topsoil is your water tank

Figure 5 – The type of your topsoil relates to the size of a water tank⁸

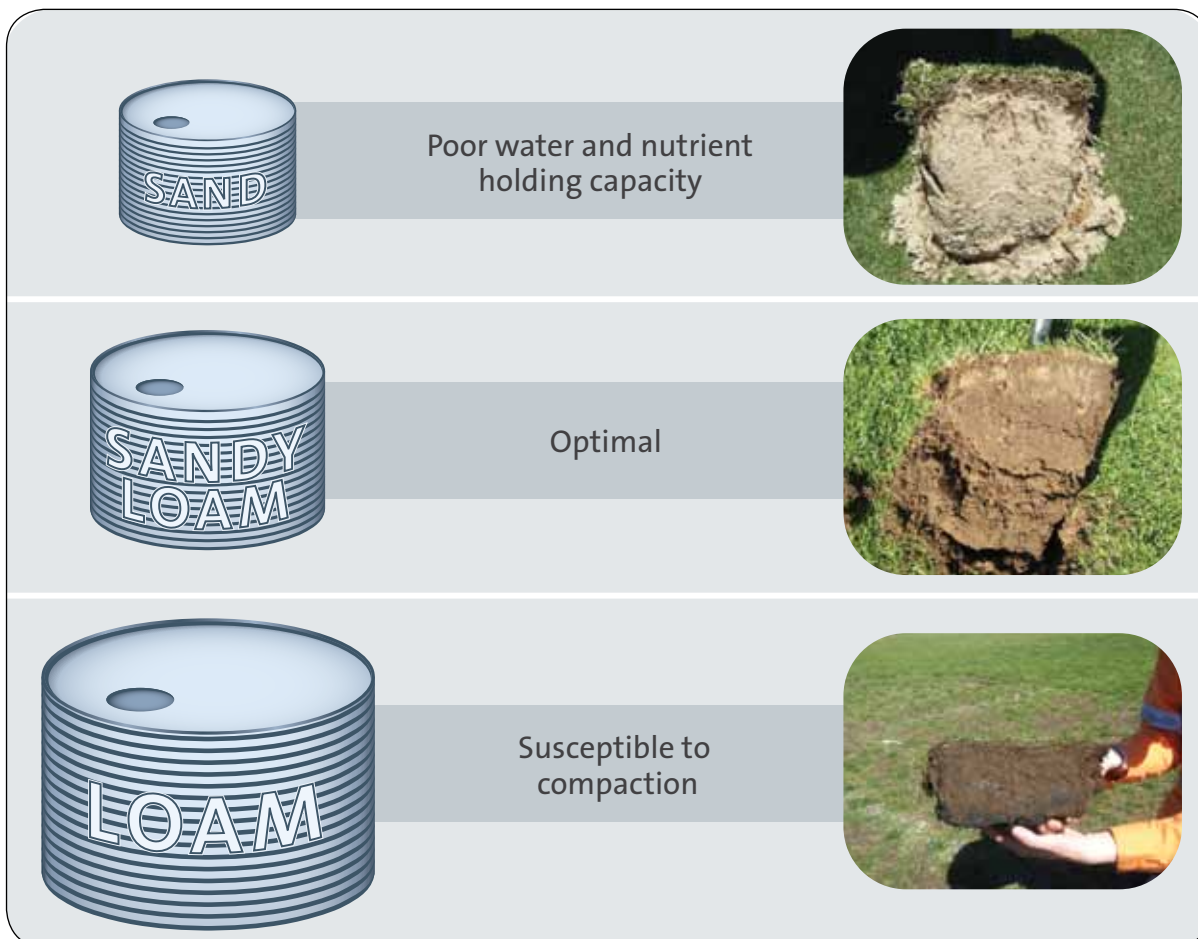

How much water can different soil textures hold?

We now know that soils act like a sponge or a tank to store water. However, the amount of water they can hold depends on the soil type.

Sand generally holds very little water for plant uptake. Loam and clay can hold large amounts of water for plant

uptake, as long as they are not compacted. Aerating a compacted clay loam can double its capacity to store water for use by turf.

Amending soil texture and depth can provide a cost effective technique to increase water holding

capacity. This improves playing surfaces and saves water. On unirrigated sites, soil improvements increase the amount of water captured and turf conditions can dramatically improve without expensive irrigation systems.

Figure 6 – Three important moisture levels of soil⁹

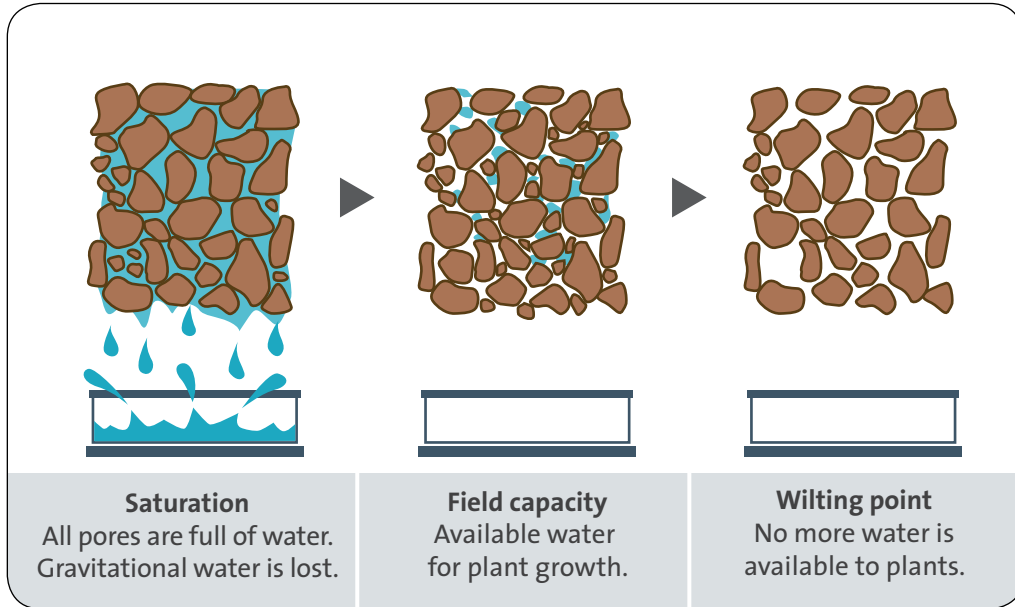

Readily available water (RAW)

Figure 7 – Readily available water¹⁰

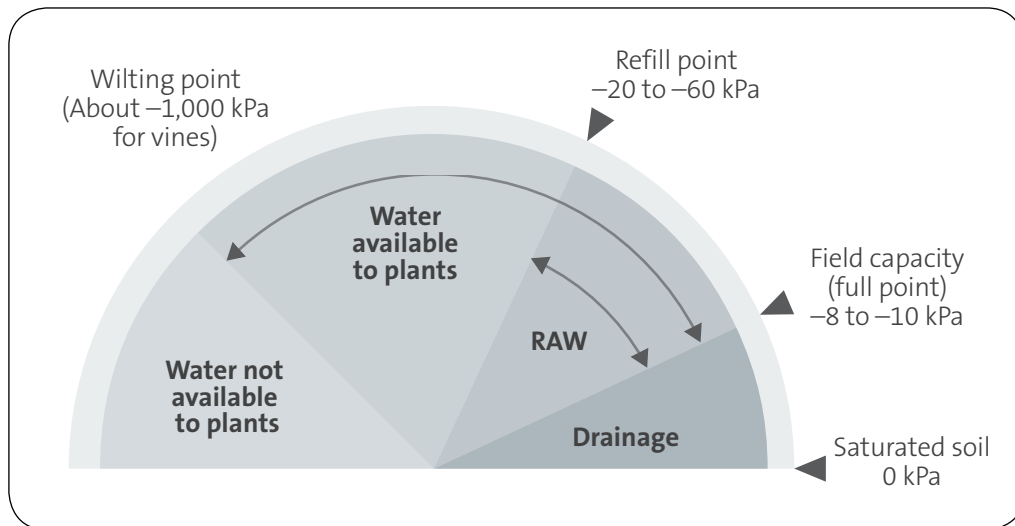

Readily available water (RAW) is the amount of water turfgrass plants can extract from the soil before the grass becomes significantly stressed. Table 3 shows an example of the RAW for different soil types in a profile that is 300 mm deep. If your

topsoil is shallower, it will hold less water.

Soil texture is a measure of the proportions of differently sized particles in the soil and can have a large influence on soil RAW. For example, sand has a RAW about

one-third that of clay loam, which means sand is less likely to capture and store rainfall. Often additional supplementary irrigation is required to sustain healthy turf growth in soils with a low RAW.

A sports field in Waverton has a sandy loam topsoil depth of 200 mm. What is the RAW of this soil?

1. Look up the sandy loam RAW in Table 3 (18 mm for 300 mm of sandy loam).
2. Given that this topsoil is only 200 mm we calculate the following:
 $200 \text{ mm} / 300 \text{ mm} = 0.66$
 $0.66 \times 18 \text{ mm} = 12 \text{ mm}$
3. We can now see the Waverton site has 12 mm of RAW.

Water infiltration into the soil surface

Infiltration rate refers to how quickly water enters a soil. Water can only enter the soil (see Table 4) at a certain rate, and the longer water is applied, the slower this rate becomes.

Compacted soils, thick turf thatch (see Part 2 – Turf) and increased slopes (see Part 3 – Irrigation and drainage) all reduce infiltration rates. Exceeding the infiltration rate can cause:

- run-off
- soil damage
- erosion
- loss of nutrients
- waste of water
- waterlogging.

Table 3 – Readily available water (mm/m) for different soil types¹¹

Soil type	RAW (mm)* held in 300 mm of soil
Sand	9
Sandy loam	18
Clay loam	18
Medium to heavy clay	19

* assumes the soil is not compacted

Table 4 – The effect of texture on infiltration rate¹²

Soil type	Infiltration rate (mm/hour)
Clay	<8
Clay loam	2 – 60
Sandy loam	20 – 60
Sand	>120

Saturated soils

After a large rainfall event the upper soil can become saturated. Saturated soils often consist of around 40 – 50% water by volume. When saturated, soils often behave more like thick liquids.

If downward water movement is not impeded, most soils do not remain saturated for long because excess water moves into drier underlying soil layers. Over time (12–48 hours) the downward movement of water from the wet topsoil will stop. At this point the upper soil is said to have reached field capacity (Battam and Sutton, 2001).

The water content of the soil at this stage is known as the field capacity percentage. Irrigating an oval beyond its

field capacity percentage wastes water and can contribute to waterlogged soil and drainage issues.

Waterlogging

Waterlogging is when more water is added to a field than it can handle. Waterlogging leads to turfgrass and soil problems.

Turfgrass waterlogging issues include:

- reduction in turfgrass vigour and quality
- reduction in root depth
- reduction in water and nutrient uptake
- reduction in turfgrass wear tolerance
- increased susceptibility to soil-borne diseases
- invasion of weed species.

When soil is waterlogged, soil oxygen is present in very small amounts. Turf is more sensitive to waterlogging during summer when the plant roots have a higher demand for oxygen (Nus, 1994). Common turfgrasses used in Sydney's open space turf areas (ie couch and kikuyu) are quite tolerant of waterlogging.

The greatest impact of waterlogging is that it reduces structural stability of soil, making it highly prone to compaction (Figure 8). When soil is close to saturation, soil behaves more like a liquid and damage can occur if the site has extra foot traffic. Even junior sports can lead to high levels of compaction if the soil is waterlogged.

Managing soil compaction

Soil compaction is one of the most common soil problems in Sydney's open space turf areas (Battam and Garland, unpublished data). Compaction occurs when soil particles are pushed together. This occurs because of foot and vehicular traffic, especially in wet weather.

Compaction decreases the pore space in the soil, resulting in:

- less water storage in the soil, making less water available to plants
- fewer air pockets and less microbial activity
- drainage and greater risk of waterlogging
- harder playing surfaces
- limited root growth, leading to limited nutrient and water uptake and reduced plant vigour

- reduced protective turf cover, making soil even more vulnerable to further compaction.

Layering within the soil profile

Soil layering of any kind (coarse soil over fine soil or fine soil over coarse soil) may restrict infiltration and cause waterlogging (Battam, 1998). Layering can occur during construction, but can also develop as a result of compaction, returfing practices and top-dressing procedures.

Adding coarse sands on top of a fine soil is a common top-dressing practice. Repetitive top-dressing can create a sandy topsoil layer (Figure 9). An underlying clay layer can restrict water movement.

Soil layers do not have to be thick to restrict infiltration. A soil layer only 3 mm thick can lead to waterlogging.

Figure 8 – The influence of waterlogging on compaction caused by foot traffic¹³

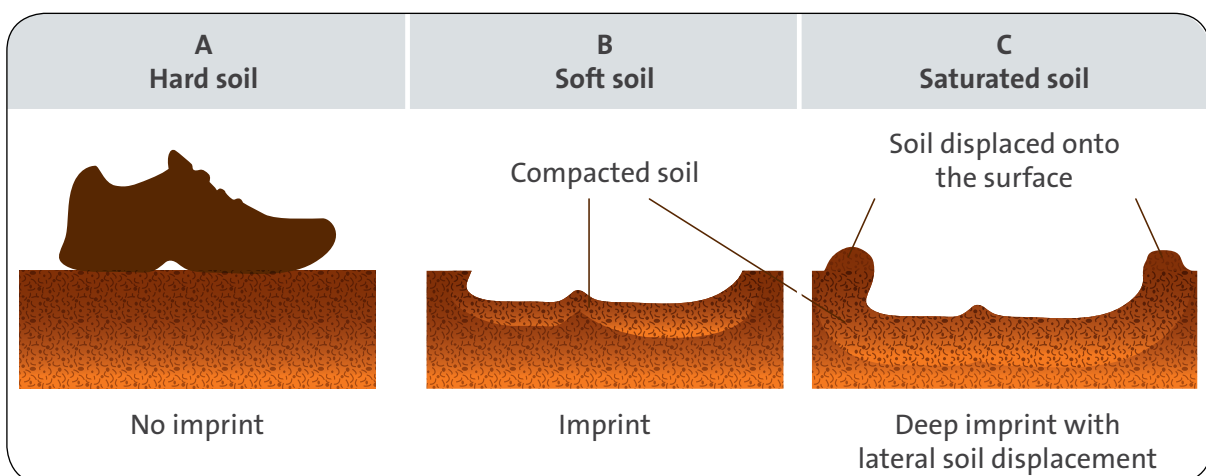

A common (and very bad) practice on Sydney sports fields is to lay clay loam turf over a free draining soil profile. This clay loam layer will restrict water infiltration into the soil profile.

Further information on best practice turf laying is in Part 2 – Turf.

Impermeable sub-base

Even if water has drained through the topsoil, underlying soil layers can prevent further downward movement.

Apart from the eastern suburbs, the sub-base underlying most turf areas throughout Sydney consists of either:

- clay soil, which is most common in the Wianamatta Shale areas (found throughout the Cumberland Plain and in parts of the North Shore) or on open space areas overlying landfill sites
- crushed sandstone, which typically has a silty sand or sandy clay texture.

If these soils are not compacted, they should allow water to infiltrate at a rate of around 1–5 mm/h.

Figure 9 – Soil layering caused by top-dressing with too sandy a soil mix²⁴



Aeration and decompaction

Aeration should be part of most sites' routine sustainable maintenance schedule.

Aeration (through mechanical action) can improve the movement of air, water and nutrients into the soil by reducing soil density. Ideally, aeration and decompaction should be done together with dethatching (see Part 2 – Turf).

The benefit of this combined dethatching-aeration technique is that new turf growth is stimulated, improving the plant's ability to produce new, deep, white roots for faster recovery.

A wide range of techniques and machines can be used to decompact open space turf areas (see Table 5).

A successful maintenance schedule may involve varying the decompaction method to ensure that the soil does not form a hardpan layer.

Table 5 – Techniques for soil aeration and decompaction¹⁵

Deep slitting or knifing		
	<p>Depth 100–300 mm</p> <p>Comments Traction-driven machines are attached and dragged behind a tractor at speed to facilitate tine or blade entry into the soil.</p>	<p>Issues In tight compact soils, tine or blade penetration is very limited. Some machines are designed so that the blades travel through the soil in an offset way, which creates a more effective disturbance.</p>
Deep slicing or 'earthquaking'		
	<p>Depth 100–300 mm</p> <p>Comments Tines gently lift and shatter the compacted soil sideways and downward. Ideal for dry hard soils and for soils with many stones, as they do not harvest materials to the surface.</p>	<p>Issues This machine is not suitable for wet soils or soils high in clay, because the soil sways to and fro as the blades pass, becoming smeared rather than fractured.</p>
Hollow tined corers		
	<p>Depth 100–200 mm</p> <p>Comments Self driven or powered by a tractor. Hollow tines 10 to 25 mm in diameter punch vertical holes in the topsoil, with the spacing between holes varying from 60 to 150 mm on a square pattern, depending on the machine brand.</p>	<p>Issues Continual use of hollow tine machines in and around the same depth in medium to heavy textured soils can cause a hardpan to develop at the bottom of the tine 'punch'. The action of the tine in penetrating finer textured soils can also cause soil glazing and compaction around the individual holes, resulting in long term soil structure degradation.</p>
Solid tine forking		
	<p>Depth 100–200 mm</p> <p>Comments Solid tines punch vertical holes in the topsoil, with the spacing between holes varying from 60 to 150 mm on a square pattern, depending on the machine brand.</p>	<p>Issues This is not regarded as an effective long-term decompaction technique because it aggravates the problems of glazing and perimeter compaction.</p>

Solid tine aeration



Depth

100–200 mm

Comments

Similar to solid tine forking, except with ‘kick’ action at the bottom of the downward thrust. Aeration is similar to putting a garden fork into the soil and rocking it back and forth, which forms a cavity underground. This action

overcomes many of the disadvantages of standard solid tine forking.

Issues

Operators of solid tine forking machines must use the ‘kick’ feature. If contractors do not use this feature they may be able to provide cheaper quotes, but it will not improve the playing surface as much.

Vibrating tines and knives



Depth

76 mm

Comments

Uses a tractor-operated power take-off to drive a rotary drum with numerous tine boots attached. The tine boots independently vibrate as the rotary drum travels forward over the ground.

Each boot has a number of tines in a square pattern that penetrate the soil while vibrating, shaking and fracturing the soil. This leaves holes in the soil allowing water to penetrate.

Issues

Continual use can still cause a hardpan to develop at the bottom of the tine ‘punch’.

Recycling top-dresser



Depth

110–180 mm

Comments

A European tractor-attached machine that decompacts, mixes and incorporates soils. Soils are aerated by a high speed rotor which drives 10 mm-wide tungsten tipped blades into the soil. The blades are spaced 180 mm apart. These blades saw trenches into the soil profile, harvesting soil and depositing into a conveyor

attachment that distributes the soil evenly at the rear of the machine, thus aerating and top-dressing in one pass.

Issues

Will not improve a lack of topsoil depth. For this you need to add material. The top-dress material generated by the machine will have a texture that matches the soil profile as it is derived from the underlying soil. So, if you have unsuitable subsoil (eg stony or heavy) this is not the best option to use.

Case study: Layering and compaction at an oval in Sylvania¹⁶

An assessment of a sports field at Sylvania revealed good loamy sand topsoil depth, but thinning turf and bare patches. These bare patches had become severely compacted and had led to topsoil layering (Picture 1). Further investigation found this was caused by re-turfing management practices.

At the end of a season, the council would lay turf on worn out areas of the field. They sourced their turf from a farm with a clay loam soil. Laying turf with a clay loam medium on top of loamy sand without proper incorporation, means the clay loam layer can become compacted and stop water infiltrating into the soil profile.

Council restored the field by:

- using an ‘earthquaking’ machine for decompaction
- using the hollow tine corer to further reduce compaction
- top-dressing the field to increase topsoil depth and even out the surface
- re-turfing some bare sections of the sports field using washed turf (ie free from the clay loam layer).

The follow-up assessment in 2010 showed a pristine playing surface, with a rich and healthy topsoil profile (Picture 2).



Picture 1 – Showing soil layering



Picture 2 – Showing healthy topsoil

Case study: Surface hardness and infiltration at an oval in Narellan¹⁷

In order to test the effectiveness of a recycled top-dressing machine, we inspected a sports field in Narellan.

We measured surface hardness using a Clegg Impact Tester. A digital penetrometer determined the soil penetration resistance (ie measuring resistance against turf root extension), and the infiltration rate was calculated using a disk permeameter.

The recycled top-dresser renovation reduced surface hardness by about 30% and reduced the variation in surface hardness across the site. It also increased infiltration by providing drainage channels for water and decompacting the soil. This decreased penetration resistance in all layers of the soil. The penetration and decompaction of the hard layers of the soil will allow root development and enhance drainage. This meant that the oval in Narellan was definitely improved by recycled top-dressing, making it greener and spongier to play on.



Figure 10 – Soils with added compost conditioner showed more resistance to compaction¹⁸



Increase resistance to compaction

Soils with a low level of organic matter can be highly prone to compaction. To overcome this problem, 10–20% (by volume) of composted soil conditioner can be incorporated into the soil profile. You must incorporate applied organic material and not leave it as a layer on the soil surface.

Better incorporation can be achieved by first soil coring, then spreading composted topsoil and finishing with mechanical sweeping of compost across the field surface to ensure good penetration into the root zone (DECC, 2007).

In a 2010 laboratory study for the Department of Environment, Climate Change and Water (DECCW), Dr Mick Battam found that soils with 10–20% of added composted soil conditioner required 40% more force to reach the same density as untreated soil (Figure 10).

Before using composts, or other soil amenders, consult a qualified soil scientist. Only use compost that meets *Australian Standard 4454 on open space turf areas* (Australian Standards, 2003). Ask the supplier to show their 'Standards Mark Licence Certificate' demonstrating that they can supply a certified product to AS 4454.

Case study: Using organics at Wingecarribee Shire Council¹⁹

A mixture of soil and composted garden organics (<12 mm fraction) was applied as 10 mm of top-dress to two soccer fields at Yerrinbool. The top-dress material was then incorporated into the soil using a solid tine aerator.

Before the trial, the site was struggling with compaction, particularly on sections of the field where the topsoil was shallow (Figure 11 'Before'). After the trial, turf condition improved significantly, especially in the shallow areas of the site (Figure 11 'After').

As well as increasing the water holding capacity of the soils, adding the composted soil conditioner increased:

- soil organic matter levels by around one per cent
- cation exchange capacity (a measure of the soil's ability to hold nutrients) by 15%
- available phosphorus levels by more than 70%
- the levels of many micronutrients.

Figure 11 – Effect of incorporating compost into the Government Road sports field²⁰



Before



After

Water repellent soils

Water repellent or hydrophobic soils cause poor turf performance across Sydney. It occurs when soil particles become covered with a fatty or waxy coating that stops water penetration (Figure 12). Hydrophobic soils can be caused by the:

- breakdown of organic matter, such as those in plant residues, compost or blood and bone
- growth of certain fungal hyphae.

You can measure the degree of water repellence by placing a water droplet on the surface of the soil and observing the how long it takes to infiltrate (Table 6).

Water repellence is more commonly observed in sands, but can still occur in more heavily textured soils, including heavy clays. It occurs naturally in some soils, but can be aggravated by:

- high levels of thatch accumulation
- soil drying out, or uneven watering

- the use of organic material that is high in fat and wax content, such as blood and bone.

Once wet, soils that are water repellent will typically behave in a similar manner to most other soils. However, as the soil dries the substances on the surface of the soil particles relocate so that the fat/wax molecules become aligned on the outer surface of the soil particles, making the dry soil water repellent.

Overcoming water repellence

As water repellence can be prevented by keeping soils moist, ensure:

- the irrigation system is watering evenly and an appropriate irrigation schedule is used
- suitable topsoil of adequate depth exists across the entire site. Shallow and sandy areas will dry out faster and are more likely to be water repellent
- the soil infiltration rate is maintained at a sufficiently high level so an adequate capture of rain/irrigation is occurring. This is particularly important on steeply sloping sites.

To reduce the occurrence of water repellence:

- dethatch turf (Part 2 – Turf)
- aerate the soil
- top-dress with a non-repellent soil material
- minimise the addition of organic matter that is high in fatty and waxy materials, such as blood and bone
- use a wetting agent.

Figure 12 – Water repellent sand. Note the sand grains are floating on the surface of the droplet²¹



Table 6 – Water droplet test for assessing the degree of water repellence²²

Time for water droplet to penetrate	Degree of repellence
<1 second	Not significant
1 to 10 seconds	Low
10 to 50 seconds	Low to moderate
50 seconds to 4 minutes	Moderate to high
>4 minutes	High to very severe

Wetting agents

Like washing-up detergent, wetting agents assist the mixing of fats, waxes and water. Wetting agents can greatly increase the infiltration rate of soils that are water repellent, allowing these soils to wet more easily.

Wetting agents treat the symptoms of water repellence and allow water to enter the soil for a period of time. They will need to be reapplied if the underlying cause of repellence is not overcome.

The decision to apply wetting agents should be based on an assessment using the water droplet test (Table 6) or when inspection of the turf reveals a 'dry patch'.

Wetting agents can pose a risk to the environment, particularly if they reach streams and dams, because the surfactants in wetting agents can harm aquatic animals. Only use biodegradable wetting agents.

Other soil issues to look out for

Soil problems are commonly related. For example, shallow topsoils are often also very compacted. Other soil problems and their effect on the performance of open space turf areas in Sydney are described in Table 7.

Table 7 – Other soil problems in Sydney open space turf areas

Problem	Symptoms	Comments	Management option
Acid sulphate soils	<p>Dead and stunted vegetation</p> <p>Acid scalds</p> <p>Acid tolerant vegetation</p>	<p>Highly acidic (pH 2-3) when drainage or excavation works expose potentially acid soils to oxygen.</p> <p>Generally located in low-lying coastal and estuarine areas, including areas of coastal Sydney.</p> <p>If sulphuric acid reaches waterways, it can kill fish and other aquatic organisms. It can also change oxygen and metal levels in waterways.</p>	<p>Before conducting any drainage or earthworks in areas of potential acid sulphate soils and acid sulphate soils, consult the guidelines and maps at www.environment.nsw.gov.au.</p> <p>You may need to:</p> <ul style="list-style-type: none"> • develop an acid sulphate soil management plan • amend construction techniques • replan the project.
Saline soils (lots of salt but not a large percentage of total salt is sodium)	<p>Direct effect on grass:</p> <ul style="list-style-type: none"> • scalding • poor plant growth <p>Not necessarily bad for soils</p>	<p>A known problem in western Sydney because of poorly drained soils formed from marine shales. Salinity may be aggravated by irrigation and earthworks that disturb flow patterns of saline subsoil waters and bring them to the surface.</p> <p>In some parts of Sydney, such as Camden, saline soils are common near the base of slopes that run down onto flood plains.</p> <p>Recycled water may have elevated levels of salts, depending on its source and treatment. Assess water and soil quality before using recycled water for irrigation. Part 4 – Holistic management discusses alternative water sources.</p>	<p>Salinity maps for western Sydney are available at www.naturalresources.nsw.gov.au</p> <p>Information about managing saline soils is available at www.wsroc.com.au</p> <p>If the only irrigation water available to you is saline, you must test soil and water regularly for sodicity and salinity.</p>

Problem	Symptoms	Comments	Management option
Sodic soils (a moderate amount of salt but a high percentage of that amount is sodium)	Poor soil structure and fertility Not necessarily bad for grasses – only the most sensitive species are affected	Anything that adds sodium to a soil increases the risk of sodicity. Sodic soils contain a high percentage of sodium ions that dissolve in the soil water. Sodium ions tend to force clay particles apart, destroying soil structure and permeability to water.	Gypsum contains calcium ions for treating sodic soils. There are certain clay soils that disperse, making gypsum effective. Try the Handreck and Black (2002) soil dispersion test: Put some soil in water and some soil in calcium chloride (CaCl ₂) solution. If the solution is clear and the water is not, then gypsum will be effective. If both are cloudy then gypsum will be ineffective (ie the soil will not react with the calcium ions in gypsum).
Saline-sodic soils (lots of salt and a high percentage is sodium)	Direct effect on grass: <ul style="list-style-type: none"> • scalding • poor plant growth Poor soil structure and fertility	See above	See above
Contaminated soils	Limited topsoil depth Poor water infiltration Contaminated leachate	Many sports fields in Sydney are located on old landfills capped with clay. Managers must ensure they do not disturb the clay cap and expose contaminants when conducting deep soil renovation, or when they are trenching to install new lighting or sub-surface drains.	Manage irrigation, so that it does not contribute to the formation and dispersal of leachate.

Part 1 – Soil endnotes

- Natural Resources Conservation Service
- www.netafimusa.com
- Mick Battam and Steve Garland
- Josh Ryan and Mick Battam
- Source <http://bettersoils.soilwater.com.au>
- Source www.dpi.nsw.gov.au
- Brady and Weil, 2002

- Craze and Hamilton, 1991
- Source: McIntyre, 2004
- Mick Battam
- Geoff Hatton
- Andrew Porter, Joshua Ryan
- Geoff Hatton, Jim Hull
- Mick Battam

- Mick Battam
- Mick Battam
- Mick Battam
- Adapted from King, 1981





Part 2

Turf

Contributors: Mick Battam, Peter Martin, Simon Leake, Geoff Hatton, Jim Hull, Steve Garland, Annie Kavanagh

The relationship between turf, soil and water

Turf is a living system. Soil is made up of nutrients, minerals and decaying organic matter. It plays host to a number of organisms, both large and small. Turfgrass requires support and sustenance from the soil (and it is from the soil that the turf plant absorbs water through its roots).

The amount of air, water, nutrients and light needed by turf are related, but not interchangeable. Far too often, we misunderstand the need for resources, for example:

- over-watering on sites that need more fertiliser
- installing expensive drainage systems on sites that actually need soil decompaction
- decompacting sandy sites
- adding too many nutrients to sites with thin topsoil.

Understanding the needs of soil, turfgrass and how water is used will help you understand the resources needed by turf, and the relationship between them. In this document, 'turfgrass' refers to the individual plant and 'turf' refers to an area of turfgrass.

Figure 13 – Comparative growth rates of couch, kikuyu, buffalo and ryegrass at a sports field in Five Dock²³

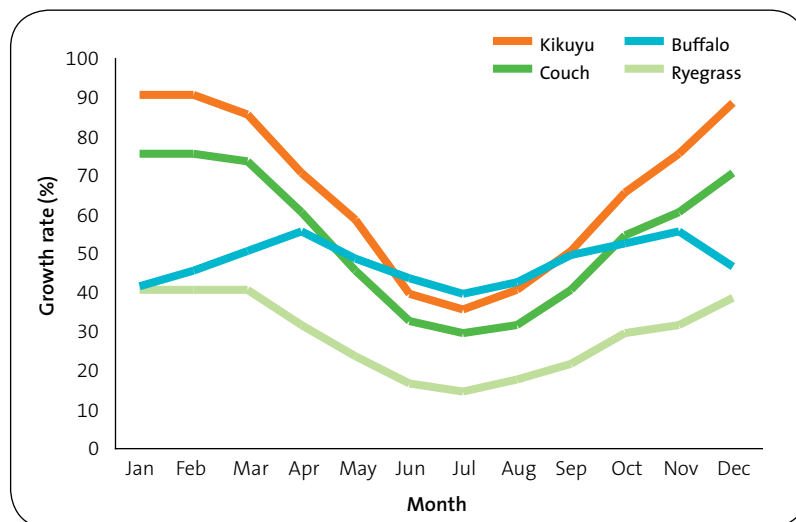

Different turfgrass species in Sydney

The main species of turfgrasses grown in Sydney are shown in Table 8. Successful turfgrasses should provide enough coverage for safety, and adequately cover the soil so that moisture can be retained.

Different species of turfgrass have different growth patterns, rates of recovery and tolerance levels. For example, temperature can affect the recovery potential of different turfgrass species in different ways. Figure 13 shows the seasonal growth rates of four different turfgrass species for a sports field in Five Dock.

Warm season turfgrasses such as couch, kikuyu and buffalo generally grow fastest when the temperature is around 38°C (Attanake, 1995; Ivory and Whiteman, 1978). At lower (or higher) temperatures, the growth rate of these warm season turfgrasses declines. Ryegrass, being a cool season

grass, displays limited growth during summer, but has a relatively high recovery potential during winter. However, because it is a cool season grass, it requires significantly more supplementary irrigation than the other three warm season species.

There are also variations within species of turfgrass. Different varieties of the same turfgrass species have different:

- growth habits
- drought and wear tolerance
- winter growth rate and colour
- pest and disease susceptibility.

For example, kikuyu has enormous variations in growth habits, with some ecotypes showing lower drought tolerance or higher salt tolerance than others (Beard, 1989). Some couch cultivars are nearly twice as resistant to wear and tear as others (Younger, 1961).

Table 8 – Characteristics of turfgrasses used in Sydney²⁴

Scientific name	Common name	Use	Common varieties	Drought tolerance	Wear resistance	Recovery from mod. wear	Recovery from severe injury	Maintenance cost/effort	Shade tolerance
<i>Pennisetum clandestinum</i>	Kikuyu	Most Recr. lawns Most Grade B SFs Some Grade A SFs	Male Sterile	High	Very high	Very fast	Very good	Low	Moderate
<i>Gynodon dactylon</i>	Couch Bermuda grass	Some Grade B SFs Most Grade A SFs Most Elite SFs	Legend, Conquest, Windsor Green, Greenleas Park, Winter Green, CT-2	Very high	Very high	Very fast	Very good	Moderate high for excellent quality	Low
<i>Stenotaphrum secundatum</i>	Buffalo	Recr. lawns	Shade master, Sir Walter, Palmetto, Sapphire, ST-85, ST-91, ST-26	High	Moderate	Moderate	Moderate to poor	Low to moderate	High
<i>*Lolium perenne</i>	Perennial ryegrass	Oversow couch on High grade SFs Cold areas-Bowral	Over 400 varieties	Moderate to low	Moderate to high	Moderate	Poor	Moderate	Moderate
<i>Paspalum dilatatum</i>	Paspalum	Low grade sports fields and low priority lawns	–	High	Moderate	Moderate to slow	Moderate to poor	Low	Moderate
<i>Axonopus fissifolius</i>	Carpet grass	Low grade sports fields and low priority lawns	–	High	Low	Moderate	Poor	Low to moderate	Moderate to high
<i>Digitaria didactyla</i>	Qld Blue Couch	Sports fields and lawns	Aussie Blue	High	Very high	Fast	Good	Low	Low
<i>Zoysia spp.</i>	Zoysia matrella	Sports fields and lawns	Zorro	Very high	Very high	Slow	Moderate to good	Low	High
<i>Paspalum vaginatum</i>	Seashore paspalum	Lawns, golf greens and tees	Velveteen Sea Isle 2000	High	High	Moderate to slow	Slow	Low	Low
<i>Dactyloctenium australe</i>	Durban	Heavily shaded lawns	–	High	Moderate	Moderate to slow	Slow	Low	Very high

* Cool season turf grass

The following factors influence the watering requirements of open space turf areas because they affect rainfall, temperature, evaporation, and the ability of the soil to hold water:

- geographical location – for example, Wollongong versus Katoomba
- microclimate – the amount of shade and windbreaks
- the level, type and frequency of traffic – for example, walking versus team sports
- desired surface quality – for example, the Sydney Cricket Ground versus the lawn behind Cronulla beach
- soil type and depth – for example, the sand at Randwick versus the shale soils of Liverpool.

How much water does turf need?

Turfgrass needs water to transport nutrients, conduct photosynthesis, and maintain cell structure. Turf water requirements are met by rainfall, irrigation or soil moisture storage.

Most of the water used by turfgrass passes directly through the plant and exits the leaves into the air. If the roots cannot keep up with the water being lost through the leaves, grasses slow the rate of water loss from the leaf by closing their stomata. Stomata are specialised groups of cells that form pores in the leaf's surface.

Closing the stomata to limit water loss also restricts carbon dioxide entry into the leaf, slowing photosynthesis and growth.

If the lower growth rate of the stressed plants is acceptable, you can water turf less than the level recommended in most turf literature (Kneebone et al. 1992).

Turf quality may even be improved by reduced watering, as the problems of over-watering some warm season species are possibly a greater hazard (Kneebone et al. 1992).

Warm season turfgrass species commonly used in Sydney need very little water to survive and are very hardy. In the harsh South Australian environment, kikuyu is listed as an invasive garden plant and couch is listed in the top ten invasive plants in the arid areas of the Northern Territory (Groves, 2005). Kikuyu and couch are both invasive weeds in Sydney as well, if you don't want them in your garden or putting green.

Permanent wilting point (PWP)

As the soil becomes drier, plant roots need to suck harder to extract water. Eventually the plant is unable to extract any further water from the soil. This is referred to as the plant's permanent wilting point (PWP).

Turfgrasses with some degree of drought tolerance do not die when the turf plant reaches permanent wilting point. When the prolonged dry period breaks, the turf regenerates from rhizomes and sometimes other plant parts.

To prevent excessively slow turfgrass growth and a loss of turf quality, irrigation should occur well before the turfgrass dries to PWP.

Recharge or refill point

The water content at which the turf starts to experience moderate levels of moisture stress (even though this may not be apparent from visual inspection) is referred to as the recharge or refill point (RP). The RAW calculations from the previous section can be used to determine the appropriate RP for your sports field.

Watering open space turf areas in Sydney

Sydney's variable rainfall can provide enough water for lawn areas that have reasonable soil and light foot traffic. During the water restrictions in Sydney (2003–2009), many residential lawns and numerous recreation areas and sports fields survived without supplementary irrigation.

During a dry spell in February 2009, when little rain fell for 20 to 30 days, some sports fields performed well despite limited irrigation. Sites with deep loamy soils performed best, with the turf able to draw on water reserves stored within the soil.

Figure 14 – Turf that has reached PWP²⁵Figure 15 – Good coverage on a rain-fed sports field one week after the end of February 2009 dry spell²⁶

Dr Mick Battam studied 50 Sydney open space turf areas during February 2009 to determine their watering requirements. He found:

- turf needed considerably less water than would be recommended by traditional irrigation scheduling techniques (eg pan evaporation/crop factor method)
- more water was needed to maintain turf at the superior quality required for elite sports fields than for lightly used local sports fields.

Moving from coastal areas of Sydney towards the base of the Blue Mountains there is a general:

- decrease in rainfall (1,200 mm a year compared to 750 mm at Penrith)
- increase in the number of days that the daily temperature exceeds 35°C
- increase in the number of days with high evaporative demand
- decrease in night time temperatures
- decrease in the number of windy days.

These differences mean that turfgrass water requirements across the Sydney region vary, even for fields of the same category (See Table 2 – Introduction).

Because of the large rainfall gradient from east to west on the Cumberland Plain, generally more irrigation is required to meet turfgrass water requirements in the Penrith area than in the high rainfall areas such as the Hornsby Plateau.

Microclimates

The microclimate refers to the localised climate around the turfed open space. Rainfall, temperature, wind and humidity may influence the microclimate, along with nearby buildings, roads, trees and shrubs. To help your turf grow, you must understand how various microclimates can affect growth rates and water use.

Sunlight

Turfgrass needs light to grow. It uses the energy in sunlight to convert carbon dioxide into plant tissue. If light is reduced, turfgrass growth is reduced and turf cover becomes thin or bare. Under low light levels turfgrass generally displays:

- thinner, longer leaves and a more upright growth habit
- reduced shoot density and root growth
- thinner cell walls and reduced wear tolerance (Beard, 1973; Dudeck and Peacock, 1992; Periera et al, 1998).

Some of these changes can occur within four to seven days of reduced light levels (Harivandi et al, 1984).

The leaves of well-shaded turf can remain wet for longer after rainfall, irrigation or dew formation. This also makes turfgrasses in shaded areas more prone to disease, particularly if high nitrogen levels are present (Beard, 1973; Beard, 1997).

The minimum amount of light needed to sustain healthy turfgrass depends on the:

- species or cultivar
- level of foot traffic (see Table 9).

Shade

Shade can be cast by buildings, trees and landscape features, such as hills and ridges. Indirect light in the form of sunflecks (Adams and Gibbs, 1994) and reflected light from windows and buildings (McVey et al, 1969) allows turfgrasses to tolerate higher levels of direct shade.

Small amounts of shade can sometimes be beneficial for turfgrasses. Midday or afternoon shade can reduce the stress of bright summer sunshine and high air temperatures on ryegrass lawns in Sydney. Shade can reduce water loss and improve the survival of turfgrass in dry weather.

Shading is more of a problem in winter. Sydney's sunlight radiation levels in winter are roughly 40% of summer levels. Winter days are shorter and the low angle of the sun casts longer shadows. This increases the size of the shaded area close to the southern side of buildings and trees.

In the southern hemisphere, the winter solstice occurs between 20 and 21 June. After the solstice, days gradually lengthen and nights become shorter. Lower levels of solar radiation and dormancy induced by lower temperatures reduce winter turfgrass growth rates.

Managing turf with low light

In shady areas you can manage turf coverage by:

- increasing light levels by pruning trees, particularly branches below 3 m height and/or selective pruning to promote sunflecks
- thinning and/or removing dense scrub plantings to promote air flow
- restricting traffic, particularly during the cooler months when turf recovery rates are slowest
- increasing the mowing height to provide a greater leaf area for light absorption and to promote a deeper root system (Beard, 1997)
- using more shade tolerant grasses such as buffalo, Durban Grass (*Dactyloctenium australe*), Basket Grass (*Oplismenus aemulus*) or grass substitutes such as dichondra (*Dichondra repens*). These alternatives generally improve coverage but only in low-wear areas

Table 9 – Minimum hours of full summer sun between 9 am and 5 pm (daylight saving time) required to sustain healthy turfgrass in Sydney²⁷

Turfgrass	Low traffic	Moderate traffic	High traffic
Couch+	4.0 hours	4.5 hours	5 hours
Kikuyu++	2.5 hours	4.0 hours	5.5 hours
Perennial Ryegrass++	2.0 hours	4.0 hours	Varies with variety
Buffalo	1.0 hours	4.0 hours	Does not tolerate
Durban grass	0.0 hours	Does not tolerate	

+ dwarf cultivars are more shade tolerant than upright varieties presumably due to higher tolerance to mowing heights that are too close, as commonly occurs in shaded areas.

++ at higher levels of shade its growth habit becomes more upright and higher mowing levels can maintain moderate levels of turf cover at higher levels of shade than 5.5 hours.

- limiting nitrogen applications in places where cool season grasses are being used (Beard, 1973)
- using alternatives to turf in highly shaded areas. In areas without foot traffic, these alternatives could include garden beds or

mulch. In areas with foot traffic, the alternatives could include mulch, synthetic turf, compacted rock dust (crusher dust) or pavers.

Options for heavily shaded areas are shown in Figure 16. Picture A shows the use of suitable turf species and higher mowing heights.

Picture B shows the alternatives to lawn, such as mulch or garden beds. For shaded areas that receive high levels of traffic, surfaces such as compacted crusher dust (C) or synthetic turf (D) should be considered.

Figure 16 – Turf and non-turf options for heavily shaded areas²⁸



Picture A



Picture B



Picture C



Picture D

Turf grows in a more upright pattern in shaded areas, making it prone to scalping if mowing heights are not increased. Table 10 shows best practice mowing heights for some common Sydney turfgrass species.

Turf and trees

In passive recreation areas, trees are often planted in the middle of turf for shade, amenity, aesthetics and habitat. It can be challenging to manage high quality turf cover under trees.

Reasons for poor turf performance under trees are listed below. These problems often interact:

- Trees cast shade, reducing light available to turf.
- Some trees release toxins into the soil to inhibit the growth of grasses (Dudeck and Peacock, 1992).
- Leaf and bark fall can smother grass.
- Trees and turf can compete for water. In dry environments water is more important than light (McVey et al, 1969) for turf beneath trees and shrubs.

Figure 17 – It is often difficult to grow turf close to large trees – mulching is a great option that looks good and is easier to maintain²⁹



- Trees and turf can compete for nutrients. If fertiliser is needed then feed deeply to encourage tree roots to remain deep (Dudeck and Peacock, 1992).
 - Soils can be water repellent because some fats and waxes are released when leaves, bark or pine needles decompose.
 - Trees with dense canopies can limit rain, reaching the understorey.
 - Soil around trees can be compacted due to reduced thatch levels, surface coverage and root stabilisation of the soil.
- Possible solutions for tree competition problems:
- Use deep-rooted trees with open canopies over turf areas.
 - Try to arrange trees so they are not grouped together, as single trees do not present as serious a problem for turf.
 - Use mulch and/or garden beds as a tidy alternative to turf cover beneath trees (Figure 17).

Table 10 – Recommended mowing heights³⁰

Grass	Sunny location	> 4 hours of shade
Hybrid couch	25–35 mm	Unsuitable for couch
Kikuyu	25–35 mm	50–70 mm
Buffalo	30–45 mm	45–60 mm
Ryegrass	25–50 mm	Varies with variety

Case study: Trees competing with turf on Paul Keating Park, Bankstown³¹

Tree competition was evident around the base of all trees in Paul Keating Park. Turf was patchy, thinning, lighter in colour or bare in these areas. The tree roots were competing with turf for water, and fallen tree leaves were limiting turf exposure to sunlight.

In addition, water repellent soils had formed in the tree-filled areas. The water repellence of the loamy sand of Paul Keating Park was likely due to decomposing organic matter deposited by the overhanging trees.

Because the trees were a vital part of the park landscape, we recommended that garden beds of mulch be constructed around the trees. This would stop the need for supplementary irrigation on grass that could not survive in shady and hydrophobic conditions.



Good nutrition leads to healthy turf

As well as sunlight, all plants need nutrients to grow and be productive. Plants get the elements and compounds they need to grow from water, the air and soil.

Turf nutrition influences the:

- growth of turfgrass
- capacity of turfgrass to tolerate wear, heat and drought
- turfgrass recovery rate.

Adequate nutrition maximises the carrying capacity of the turfgrass area and minimises the effects of wear, shade and heat stress.

In general, the greater the foot traffic on a site, the greater the need for extra nutrition, so that turfgrass can grow and repair damage. Lightly used sites can cope with few additional nutrients and less frequent mowing.

Best practice soil fertility for turf growth

Good soil fertility can be achieved by ensuring the soil has:

- no toxins or contaminants
- a $\text{pH}_{\text{CaCl}_2}$ of 4.5-7.5 (depending on turf species and site use)
- a relatively low salinity level – $\text{EC}_{1:5} < 0.6 \text{ dS/m}$ (although some grasses can tolerate higher levels)
- a moderate to high Cation Exchange Capacity ($> 5 \text{ meq/100 g}$)
- appropriate levels of nitrogen, phosphorus,

potassium, sulphur and micronutrients (critical values depend on the test method used).

When do we need extra nutrients?

Fertilisers or organic compost products can supply additional nutrients to turf when existing levels are inadequate. This can occur when:

- **the soil has low fertility.** Natural soils in Sydney and the sandy soils commonly imported to construct playing fields are often inherently low in nutrients
- **the soil is prone to leaching.** Soils used to construct playing fields in Sydney typically have low levels of organic matter and poor nutrient-holding ability. This means nutrients are leached from the soil during rainfall and irrigation. Large quantities of nitrogen, potassium and phosphorus can be lost in this way
- **there is reduced nutrient recycling in turf systems.** The nutrient cycles that occur in a natural vegetation community are disrupted in managed turf areas. Nutrients contained within lawn clippings are often removed from the site
- **rapid regrowth is needed** to maintain turf condition on heavy traffic areas.

Turf that gets heavy foot traffic may need regular additions of nitrogen, phosphorus, potassium and sulphur, if these are not contained in the soil in sufficient quantity.

Nitrogen is a key nutrient in promoting the quality of turf cover. Nitrogen stimulates the growth of leaves, tillers (side stems) and stolons (horizontal stems).

In high quality, high wear turf areas (such as soccer goal mouths), nitrogen fertiliser should be added fortnightly to monthly during the warmer months. This can be done less frequently if controlled (slow release) fertilisers are employed.

Where high quality warm season turf is oversown with a cool season grass, such as ryegrass for winter colour and wear, a modified nitrogen feeding program should be continued through the cooler months.

Phosphorus, potassium and sulphur should be added as required, by selecting turf fertilisers that contain these elements as well as nitrogen. This should generally happen twice a year.

NPK ratio

All fertilisers are labelled (as required by law) according to the percentage of the major plant nutrients nitrogen (N), phosphorus (P) and potassium (K) they contain. This is called the NPK ratio and is typically expressed as N:P:K.

For example, an establishment fertiliser for turf may have an NPK ratio of around 10:20:0. We can see immediately it has a high P level relative to N, and contains no K.

Common deficiencies

Some elements essential for turfgrass nutrition and their function are shown in Table 11. Deficiencies in any of these elements lead to reduced growth and vigour.

Elements such as nickel and chlorine are essential to turf growth, but are rarely deficient in nature.

Elements such as selenium, sodium and silicon are beneficial for plants, but

not essential for normal growth. Soil fertility will also be affected by pH, salinity and the presence of toxins or contaminants.

Table 11 – Functions of turf plant nutrients and symptoms of deficiency³²

Element	Role in the turf plant	Deficiency symptoms
N – nitrogen	Chlorophyll and protein synthesis. The main nutrient to promote good surface coverage	Overall paleness, slowed growth, reduced turf density, weed invasion
P – phosphorus	Cell division and growth	Reduced root and shoot growth, stunted dark green to reddish foliage
K – potassium	Water translocation and cell wall turgidity. Important to drought and wear resistance	Reduced shoot length and root growth. Tip dieback, yellowing older leaves. Decreased disease and drought tolerance
Fe – iron	Enzyme function (chlorophyll and nitrate)	Yellowing and chlorosis (striping in grasses) to complete whiteness. Reduced root growth
Ca – calcium	Cell division and growth	Reduced root growth and disease resistance, red-brown leaf margins
Mg – magnesium	Chlorophyll production	Uncommon. Reddish leaf margins, mottling
S – sulphur	Protein synthesis	Overall paleness, midrib remains green
Mn – manganese	Enzyme function	Uncommon. Yellowing and chlorosis
Zn – zinc	Hormone function and shoot growth	Uncommon. Stunted puckered leaf margins
Cu – copper	Cells at growing points	Uncommon. Tip dieback, yellowing
B – boron	Root and tip growth	Reduced root and shoot growth
Mo – molybdenum	Nitrate utilisation	Uncommon. Apparent nitrogen deficiency. Stunted growth. Pale green or yellow leaves.

Visual assessment (appearance, colour, growth rate)

Reasonable decisions about when to apply nitrogen fertilisers can be made by assessing the colour, density and growth rate of turf. Generally, you can see when turf is deficient in nitrogen, phosphorus and iron.

Other deficiencies can be difficult to identify from visual symptoms alone (Beard, 1973). For many other nutrients, turfgrass growth and resistance to stresses will have declined due to ‘hidden deficiency’ long before visual symptoms occur. A long-term downward trend in potassium levels, for example, usually won’t be seen until levels have dropped significantly.

Test soil and foliage regularly to identify other nutrient deficiencies before turf condition deteriorates significantly. Independent laboratories can help you analyse soil and foliage.

Soil testing

Regular soil testing is essential for long-term nutritional management. Emerging problems such as acidity, salinity, declining levels of organic matter, and deficiencies of potassium, phosphorus and trace elements can all be anticipated by testing soil.

There are many different types of soil chemical tests. Some

estimate the level of ‘available’ nutrients in a soil, and others measure the total reserves of nutrients. It is important to ensure the soil laboratory selects a soil nutrient test that is calibrated for turfgrasses, not fast growing crops. While tests vary from lab to lab, an example of an appropriate extractant for turf soil testing is the ‘Mehlich 3’ test. This test can be used for most of the common nutrients needed for turfgrass, except nitrogen.

Soil tests must be interpreted in the context of the method used, turf species, site history and soil type. Speak to a qualified soil scientist for a correct analysis before deciding on a fertiliser regime.

Foliar analysis

Foliar analysis determines the nutrient levels in the leaves and shoots of turfgrass. It allows you to confirm whether an element is deficient in turfgrass, even when there are sufficient nutrients in the soil.

If nutrients are deficient in the turfgrass but present in the soil, this indicates unfavourable soil conditions. It can show whether disease or insect attack is affecting root function and uptake of nutrients from the soil.

Foliar analysis is most valuable when used together with soil analysis. Interpreting foliar analysis is difficult because of the numerous factors involved (Smith and Loneragan, 1997).

Interpreting foliar analysis is difficult because of numerous factors:

- Sometimes it is difficult to see evidence of gross deficiencies or toxicities (clinical deficiency) in the nutrient percentage results of foliar analysis. If a nutrient is limiting the plant’s growth, its growth can slow, causing the mineral composition to remain close to normal.
- There are many complex nutrient interactions making it difficult to distinguish between a real and a physiological deficiency. For example, growth may be limited because excess phosphorus renders the copper physiologically inactive, not because of low levels of copper.
- There are difficulties in distinguishing physiologically active nutrients in living cells from those on the exterior of a leaf or in non-living cells such as fibres. Iron is a particularly difficult element to distinguish as turf foliage samples are often contaminated with surface iron deposits and fine soil particles.

It’s wise to consult your laboratory technician for expert interpretation of soil and foliar analysis.

Nutrient levels within turf vary seasonally. It is generally best to sample during spring,

as this is the active growing season for warm season grasses in Sydney.

Mid-summer testing is also useful to assess the effectiveness of the spring fertilising program.

Understanding nutrient requirements

In some cases, specially formulated fertilisers that supply N, P, K and S are used on high quality turf throughout the year together with soil testing, to ensure that elements such as P are not building up in the soil.

Limited resources often lead to medium or lower quality fields getting less than the optimum levels of nutrition.

The effect of available fertilisers can be maximised by using:

- N-P-K-S fertilisers in the spring, together with dethatching or other renovation practices
- nitrogen fertiliser once or twice, during the warmer months.

After the initial application of phosphorus when turf is being established, hard-wearing turf will need regular, but smaller applications of phosphorus.

Maintenance fertilisers will typically have an NPK ratio of around 12:3:8 for balanced nutrition. For soils that have excessive phosphorous, a zero-phosphorous fertiliser should be used.

Many native soils and quarried commercial soils are acidic and low in calcium. Liming can add calcium and increase the soil pH. Most clay subsoils would benefit from the addition of either lime or gypsum. Unamended clay subsoils in the Sydney region are often not suitable for cultivating plants.

When magnesium is deficient in an acid soil, you can use dolomite to increase the pH and magnesium content at the same time.

If the soil pH requires no correction but calcium levels are low, then gypsum should be used. See Tables 12 and 13 to see how to manage and interpret soil pH.

Table 12 – Use of lime, dolomite and gypsum for various soil pH and Ca:Mg scenarios³³

Soil is acidic		Soil is neutral (pH 5.0-6.5) Optimal	Soil is alkaline
Soil is high in Ca low in Mg	Magnesite or Dolomite	Epsom salts	Epsom salts and Iron Sulphate
Ca and Mg are balanced	Dolomite/lime	No action	Iron Sulphate
Soil is low in Ca high in Mg	Lime	Gypsum	Gypsum and Iron Sulphate

Table 13 – Soil pH and turfgrass responses to lime and iron³⁴

Extreme acidity	Strongly acidic	Slightly acidic (optimal)	Neutral to alkaline	Alkaline
pH <4	pH 4.0-5.0	pH 5.0-6.5	pH 6.5-7.5	pH >7.5
High probability of response to lime	Response to lime likely in high quality turf	Low probability of response in any turf	Likely response to iron in quality turf	Likely response to iron in any turf

Liming is an important maintenance practice even on very low input turf areas. Liming is normally done every five to seven years on the basis of soil test results. To assist in incorporation, soil improvers such as lime can be mixed with top-dressing before coring.

The following sources can provide further information on nutrition regimes:

- Handreck and Black, *Growing media for ornamental plants and turf*, fourth edn, University of NSW Press, Sydney, 2010.
- Carrow, Waddington and Reike, *Turf Grass Soil Fertility and Chemical Problems: Assessment and Management*. John Wiley & Sons, Hoboken, New Jersey, 2001.
- Waddington, Carrow and Shearman (eds), *Turfgrass*. American Society of Agronomy: Madison, Wisconsin, USA, 1992.
- McCarty, *Fundamentals of turfgrass and agricultural chemistry*. John Wiley & Sons, Hoboken, New Jersey, 2003.

Adding nutrients with organic products

Table 14 shows the nutrient content of organic products. There are dozens of traditional organic fertilisers available, but you should also consider local products. Organic fertilisers work better if they have been aged or composted. Organic material that has been composted is normally good for nutrient and water retention.

Table 14 – Nutrients supplied by organic products³⁵

Organic product	Nitrogen	Phosphorus	Potassium	Notes
Hoof and horn	11 – 13	0.3	–	High potential for water repellency if applied to sandy soils
Blood and bone	4.5 – 5	5	–	
Blood meal	10 – 13	0.3	–	
Fish meal	5 to 12	9 to 16	2 to 4	These products supply a full range of micronutrients
Biosolids*	0.8 – 4.3	0.2 – 1.8	0.02 – 1.7	
Composted garden organics**	2	0.35	1.1	
Poultry manure*	4 – 8	1.1 – 2	0.8 – 1.6	
Poultry litter*	1 – 1.7	0.25 – 0.8	0.8 – 1.2	
Cow manure	0.2 – 2.7	0.01 – 1.0	0.06 – 2.1	
Sheep manure	1 – 3	0.1 – 0.6	0.3 – 1.5	

* Nutrient content based on dried sample

** Only use composted material that adheres to AS4454

Managing insects, weeds and diseases

Healthy turfgrass is more likely to resist weed invasion and damage from pests and disease. Healthy, aerated soil, balanced nutrition, and adequate water at the right time will help maintain the resilience of your turf.

Ensuring contaminated soil and turf is not imported onto your site will also prevent outbreaks of new pests, weeds and diseases in your open space turf area.

Weeds

Weeds compete with turfgrasses for space, water, nutrient and light. Some weeds also produce substances that harm turfgrasses. Weeds in turf can be grouped into three categories:

- grass weeds
- broadleaf weeds
- sedge-like weeds.

Some common turfgrasses can be regarded as a weed when they occur where they are not wanted. For example, couch can invade bent grass putting greens.

A table of weeds commonly found in Sydney turfgrasses is presented in Appendix A.

The growth period may not include the period of greatest impact of the weed. For instance, bindii (*Soliva pterosperma*) is a far greater nuisance after it is dead, due to its dried spines, which

Figure 18 – Clover is a common weed in Sydney turfgrass



cause discomfort to animals and people.

Some weeds, such as wintergrass (*Poa annua*), persist in irrigated turf, whereas in unirrigated conditions they would disappear in summer.

Some types of wintergrass only grow in winter, while others germinate throughout the year. The list in Appendix A is not exhaustive and the turf manager is encouraged to use available resources to identify other weed species.

The following sources can also help identify weed species:

- Weeds Australia – a useful tool for identifying weeds (www.weeds.org.au). This tool is searchable by district and/or weed type.
- *The 'Ute Guide'* – developed by the South Australian Department of Primary Industries and Resources. A small pictorial handbook of weed species organised by growth habit

and shape. This is a very compact and handy guide to common weed species, including many that inhabit turf areas.

- *Weeds: An illustrated botanical guide to the weeds of Australia* (Auld and Medd, 1992) – is a well-illustrated book that includes most of the weeds a turf manager in Sydney is likely to encounter.

If you can't identify the weed, the Royal Botanic Gardens Sydney provides a plant identification service for a small fee (www.rbgsyd.nsw.gov.au).

Preventing weeds – best practice

The best way to prevent weed infestation is to maintain a complete, healthy cover of turfgrass. This can inhibit weed growth because it limits the amount of water, nutrients and light that weeds can access, reducing the germination of weed seeds and preventing ground disturbance.

Removing weeds

Weed infestations can be removed with physical and chemical measures, including:

- pulling, grubbing, slashing, cultivating, shaving and mowing
- burning and searing
- salt burning (for salt tolerant turfgrass species)
- chemical control.

Major weed infestations require chemical control. A wide variety of chemicals is available. However, alternating chemical groups (and therefore modes of action) is recommended to prevent tolerance and resistance to herbicidal chemicals developing.

A less disruptive process for controlling weeds is to apply pre-emergent herbicides. The turf is allowed to grow without competition from

weeds, and there is normally less stress or growth modification imposed on the turfgrass.

Insects, nematodes and mites

Insects, nematodes and mites can damage turf roots, shoots and leaves. These pests can affect the uptake and use of water by:

- chewing roots, affecting the ability of plants to take up water
- chewing stems, disrupting water flow through the plant
- injuring leaves, causing water loss through the wounded plant surfaces.

Some of the common insects and pests affecting turfgrass in Sydney are listed in Appendix B. Their season of greatest impact is indicated in the table, however the pests can be found and

damage can occur outside these ranges – especially in times of unseasonal weather conditions.

The following sources can also help you identify pest species:

- The Australian Turfgrass Research Institute's *Disease, Insect and Weed Control in Turf* provides a good overview of local turf pests.
- *Destructive Turfgrass Insects: Biology, Diagnosis and Control* (Potter, 1998) and *Controlling Turfgrass Pests* (Fermanian et al, 1997) both provide good descriptions of turfgrass insects in the USA. Many of these also occur in Australian turf.
- A new book on Australian turf insects, by Beehag and Kappro, is due for release.

Once an insect has been tentatively identified, the CSIRO entomology website may help to confirm its identity (www.ento.csiro.au). The tool is organised by common name and distribution in Australia. Not all species are pictured.

Figure 19 – Bill bug infestation



General principles of pest prevention

Healthy turf with aerated soil is more resistant to pest damage and recovers more quickly. Avoiding excessively low mowing will help turfgrass tolerate higher levels of pest infestation.

Control fertility with a balanced turf nutrition program, as the succulent growth promoted by heavy nitrogen fertilisation makes turf vulnerable to pest attack. Thatch control is important because insect pests can thrive in excessive thatch accumulation.

Quarantine and sanitation practices are particularly important in preventing insect infestation in areas where pest insects are not present. Insects, mites and nematodes can be imported into an area in turf, soil, seed and vegetative material. Prevent infestation by inspecting and testing these materials before delivery, and rejecting them if they are contaminated.

Some turfgrasses possess a natural resistance to insect infestation. Some varieties of perennial ryegrass and tall fescue host endophytic fungi of the *Neotyphodium* genus, which reduces insect attack.

Figure 20 – Be alert to the presence of pests in turf



Detecting and removing pests

You must be alert to the presence of pests in turf, as they are often hidden by the plants or soil, or are too small to detect easily. Look out for symptoms of turf damage, especially during the infestation seasons listed in Appendix B.

You can also actively monitor turf to detect pests before damage is visible. Monitoring techniques include:

- cutting sample plugs of turf to inspect for larvae and pupae of white grubs such as African black beetle, cockchafers and other scarabs
- stimulating adult pests to come to the surface by applying very dilute pyrethrum or pyrethroid solution, soapy water, or plain water to the turf surface
- trapping pests in pitfall traps made by inserting a smooth-walled container into the turf surface
- inspecting clippings for pests
- setting lures, sticky traps or baits for pests
- inspecting soil, roots, leaves or stems for pests, using a magnifying lens, pocket microscope or portable digital microscope.

Biological control exists for some turfgrass pests. White grubs such as African black beetle and cockchafers can be controlled with entomopathogenic (parasitic) nematodes. Pests such as armyworm can be controlled with registered products containing the bacterium *Bacillus thuringiensis*.

There are many products on the market that are derived from organic sources such as sesame meal and the neem tree. Use independent trial data to evaluate the effectiveness of these products before purchasing.

Chemical controls should be used as part of an integrated pest management program, where all control options are considered and applied as appropriate. All pesticides used in NSW must be registered

by the Australian Pesticides and Veterinary Medicines Authority (APVMA) before they can be manufactured, supplied, sold or used.

The *Pesticides Act 1999* (NSW) requires you to read all the label instructions, and carefully follow all the instructions on the label when using pesticides.

It is an offence to use a pesticide in a way that causes injury or likely injury to another person, damage or likely damage to another person's property, or harm to a non-target plant or animal.

Information on the *Pesticides Act* is available at www.environment.nsw.gov.au.

Use the following information to find insecticides, miticides and nematocides registered for use on turf in Sydney:

- INFOPEST – a national database CD or DVD for responsible chemical use. This information package is produced by Biosecurity Queensland and can be ordered from www.dpi.qld.gov.au.
- The Australian Pesticides and Veterinary Medicines Authority website (www.apvma.gov.au) provides some accessible information in the INFOPEST database.

Turfgrass diseases

Diseases that affect turfgrass are predominantly fungal, though bacteria, viruses and mycoplasma can also cause problems. Some of the more common diseases of turfgrass found in Sydney, and their season of greatest impact, are provided in Appendix C.

The University of Sydney Amenity Horticulture Research Unit is investigating a number of diseases of couch, kikuyu and buffalo, which are not currently listed as diseases of turf in New South Wales. Some of these diseases appear to be completely new to science.

Correctly identifying disease organisms is essential to managing the problem. Unless the disease is easily identified

Figure 21 – Encourage healthy turf growth to prevent disease



from its symptoms, identifying the organisms that are causing the problem is a job for an experienced turfgrass pathologist. The following universities offer guidance on how to contact an experienced turfgrass specialist:

- University of Sydney www.usyd.edu.au ('find an expert' section)
- University of Western Sydney www.uws.edu.au.

Your turf supplier will also be able to direct you to a reputable turf specialist.

If you need a pathologist to identify a turf disease:

- collect a sample of diseased turf as soon as symptoms appear. Ideally collect three samples: one sample from the centre of the diseased area, one from the junction of the diseased and healthy areas and one from an unaffected area
- keep the sample(s) cool (but not frozen) and ship as quickly as possible to the pathologist
- include a description and ideally some high quality photographs of the affected area.

Preventing disease

Turf management strategies that are useful in preventing or minimising fungal disease infection include:

- maintaining adequate turfgrass fertility
- minimising leaf and crown wetness
- minimising thatch
- sanitary procedures that prevent the spread of fungal spores or hyphae, or infected plant material
- minimising turf stress.

Controlling disease – biological and chemical

Some soil management practices, such as adding lime, can promote the beneficial microbes that already exist in your soil (Harris et al, 2006).

Several product manufacturers claim that adding specific fungi, bacteria or groups of organisms will produce beneficial effects on turf performance. These microbes are usually intended to establish a beneficial relationship with plant roots. Be careful when selecting your supplier, because many inoculums are geared towards agricultural crops, not turfgrasses.

As mentioned above, you should consult the AVPMA or INFOPEST database for information on chemical control of diseases.

Managing turf thatch

Thatch is the tightly combined layer of dead and living stems and roots of the turfgrass. It develops between the zone of green vegetation and the soil surface (Beard, 1973). Excessive thatch can:

- impede water infiltration
- increase water retention within the thatch layer
- increase insect and fungal infestation
- make the surface too spongy to play on.

Open space managers should allocate time during spring to mid-summer to remove thatch if necessary. This allows the turf to recover with strong regrowth in the following winter season. Table 15 lists some common renovation methods for dealing with excessive thatch.

Removing thatch debris

Gathering up turf scarification debris and spreading it at new sites to establish new turf may be regulated under the *Protection of the Environment Operations Act 1997 (NSW) (POEO Act)*.

For further information on how to appropriately remove grass clippings and thatch

debris from your open space turf area, visit:



- NSW Department of Environment, Climate Change and Water at www.environment.nsw.gov.au/waste/RegulateWaste.htm
- Sydney Environmental Soil Laboratory at www.sesl.com.au.

Replacing turf

Before attempting to re-establish turf, you must address the causes of turfgrass deterioration, as mentioned in the preceding chapters.

Budgetary, resource or time constraints will influence the decision on what turf replacement method to use.

Table 15 – Renovation techniques to remove excessive turf thatch³⁶

Scarifying	
	<p>Depth 30 mm</p> <p>Comments Self-driven machines can be used on small areas. For large areas, tractor-driven models are available that have power-driven high rotation reels with blades spaced from 20 to 50 mm apart. Removes about 10% thatch per pass. Up to five passes may be made to remove more thatch. Some machines have hoppers to remove debris. Others require a sweeper or vacuum to clean up debris.</p>
Shaving or thatch mowing	
	<p>Depth Up to 50 mm</p> <p>Comments Most effective method of thatch removal. Between 4 and 12 mm of thatch is removed on a 2 m wide flat plane. Shaving machines are tractor mounted and fitted with conveyors that deposit debris directly onto trucks for removal and recycling. Mowing can completely shave out the plant crowns of weeds, which reduces the need for chemical weed control. Can be used to maintain a consistent level surface. Following shaving, managers should aerate and then top-dress the remaining minor hollows.</p>

In order of best outcome, the following methods are available:

1. Using washed turf.
2. Sprigging, stolonising or row planting.
3. Growing turf in similar soil (or coarser) to that at the destination.
4. Using turf from the same soil at the same site (eg from beside the sports field).
5. Ensuring turf that contains any significantly different material to the underlying soil is fully incorporated.

Instant turf

Instant turf is obviously very quick to establish. With the advent of maxi or jumbo rolls, areas of 3,000–5,000 m² can be laid in a day.

Unfortunately, turf sod often contains soil material from the turf farm that has a heavier texture than the soil on which it is being laid. Once the turf is established, these two soil materials must be mixed using an appropriate renovation technique, to prevent problems with layering and waterlogging.

On a quality sand profile, such as on an elite sports field, always avoid using sod with inappropriate soil attached. Use pre-washed soil-free turf,

Figure 22 – Instant turf is quick to establish



or establish turf by sprigging, if sufficient time is available.

When using instant turf you must:

- lay sod on moist soil
- ensure the sod is not stretched during laying
- peg sod on steeper slopes.

About six to eight weeks after laying turf, penetrate the soil layer with a corer to a depth of 50–100 mm. This will help mix the turf sod soil and the existing soil.

Sprigging

Sprigging is establishing new turf from grass stolons and rhizomes. Sprigs are harvested from sod cut at a shallow depth and chopped into 30–50 mm lengths. Sprigs are either planted

in small furrows or spread onto the surface and:

- inserted into the soil with purpose-built tools, lightly power harrowed and rolled or
- covered with a soil-based top-dressing.

Ideally, about 30% of the sprig should remain above the soil surface (Adams and Gibbs, 1994).

Turf coverage from sprigs can be achieved in six to eight weeks, with the surface playable in 10 to 14 weeks. However, successful sprig establishment is highly dependent on the weather and how well the site is managed, particularly during the first two weeks.

Part 2 – Turf endnotes

23. Battam 2009 unpublished data; Martin pers. com.

24. (adapted from Beard, 1973; Harivandi et al. 1984)

25. Mick Battam

26. Mick Battam

27. Mick Battam and Peter Martin

28. Mick Battam and Steve Garland

29. Mick Battam and Steve Garland

30. adapted by Peter Martin from Emmons, 1999

31. Alisa Bryce and Andrew Porter

32. Simon Leake and Peter Martin

33. Sydney Environmental Soil Laboratory

34. Sydney Environmental Soil Laboratory

35. adapted from Handreck and Black, 2002, Martin et al, 2009

36. Geoff Hatton





Part 3

Irrigation and drainage

Contributors: Mick Battam, Peter Martin, Rohan Brown, Tony Spinks, Tim Gilbert, Geoff Hatton, Steve Garland

Irrigating turf

You should only irrigate when there is not enough rainfall to meet the needs of soil and turfgrass. Irrigated open space turf areas in Sydney Water's supply area use over 3 million kilolitres of water every year.

Efficient and effective irrigation is a fundamental principle of open space management. Optimising irrigation can cut costs, water use and the incidence of pests and diseases. Further information on optimising your irrigation schedule can be found in Part 4 – Holistic management.

How efficient is your irrigation system?

Ideally, irrigation systems should apply water uniformly, so that all parts of the irrigated area receive equal water. However, irrigation systems generally do not apply water evenly, for reasons including:

- poor design
- poor maintenance
- the effect of wind during water application.

The less evenly the irrigation system applies water, the more watering time is required to get the minimum amount of water to the worst performing parts of the irrigated area. This wastes water and potentially causes a decline in turf performance (due to waterlogging) on those areas of the field receiving excess water.

Therefore, increasing the uniformity of your irrigation system can drastically reduce water use and waste. Irrigation Australia Limited (IAL) recommends that your irrigation system meets a minimum distribution uniformity (DU) of 75%. Calculation of DU is explained in more detail below.

DU is measured in a field test using a series of catch cans to collect water emitted by an irrigation system. A recognised competent irrigation professional should do this test for you. For further information on how you can find a competent recognised irrigation professional to test the DU of your irrigation system, visit www.irrigation.org.au and look for the listing of certified irrigation professionals in your area. IAL's website also includes training sessions on how to measure the DU of your irrigation systems.

DU is defined as:

$$DU = \frac{\text{Average low 25\% (mL)}}{\text{Average (mL)}} \times 100$$

Where:

DU =	Lower quarter distribution uniformity
Average low 25% =	Average of lower 25% of catch can readings (ie cups that caught the least amount of water)
Average =	Average of total catch can readings

A high DU value means the system is applying water relatively evenly and efficient irrigation sessions can be run. As DU values decrease, there is a potential for:

- increased water waste
- waterlogging on parts of the field
- drought stress on other parts of the field
- excess water draining away from the site.

Figure 23 – Densogram for Hunter I21 sprinklers #6 at 550 kPa square spacing. The areas of blue indicate wetter areas³⁷

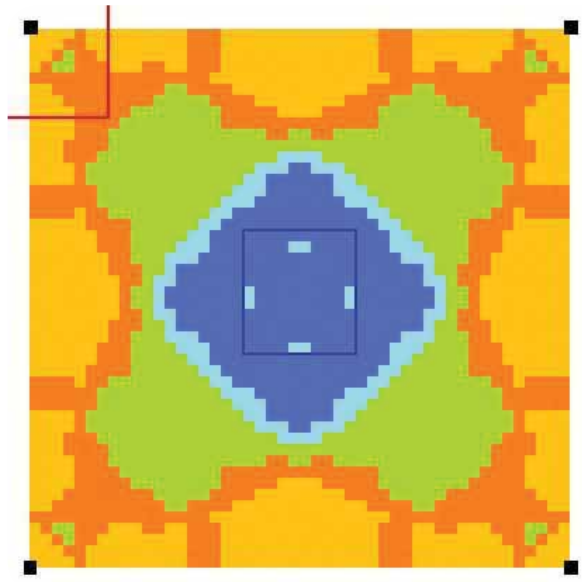

Case study: Working out the irrigation system efficiency for a soccer field³⁸

A one hectare local soccer field with a 200 mm well-structured sandy loam profile needs 12 mm of water for every irrigation event. The irrigation system theoretically delivers 12 mm of water an hour. With perfect distribution, each irrigation event could last about 60 minutes and deliver about 120 kL of water. Assuming this field is watered once each week in summer, you would use about 2,600 kL for the season.

This particular irrigation system has a poorly performing DU of 55%. This means water is only being applied at about 6.6 mm/hour on average to one quarter of the field. Therefore, the system would have to run for about 109 minutes to make up for the lack of water in this section of the field. This means applying 218 kL of water each irrigation event. Assuming this field is watered once each week in summer, you would use about 4,727 kL for the season.

By increasing the DU of the irrigation system to 75%, the irrigation system would only need to run for about 80 minutes, applying 160 kL of water each event. Irrigating over summer would use 3,467 kL, which equates to 1,260 kL water savings compared with the 55% DU.

This saves 1,260 kL (or 27%) compared to the 55% DU. If you avoid irrigating during very windy conditions and during the hottest parts of the day when evaporation is greatest, irrigation will be even more efficient.

Figure 24 – The effect of poor DU on turf performance (ie green rings)



Irrigation system design

Irrigation systems must be designed, installed and commissioned by competent, recognised irrigation designers. Irrigation design involves calculating turf water needs and developing irrigation schedules to match the site characteristics (such as soil types and infiltration rates) and constraints (such as sporting training schedules). These factors will determine the design of the irrigation system, including sizing, selection and layout of emitters, pipes, valves, pumps, water meters and irrigation control components.

A list of certified irrigation designers is available from Irrigation Australia Limited (IAL) at www.irrigation.org.au.

See Appendix D for a list of existing standards and guidelines for irrigation systems. These guidelines cover regulatory standards for accessing water supplies, occupational health and safety and other public health matters.

Water supply pressure

Sydney Water must ensure that properties connected to its water supply system have water pressure

at the main tap of at least 15 metres head (about 150 kPa). Exceptions to this are urban areas next to reservoirs in the Blue Mountains and non-urban areas in Bayview, West Camden, Llandilo, Berkshire Park, Castlereagh, North Richmond, Oakville, Riverstone and Schofields.

Backflow prevention containment

The purpose of Sydney Water's Backflow Prevention Containment Policy is to protect Sydney Water's drinking water supply, by reducing the risk of contamination by backflow from connections to the drinking water supply system.

Non residential properties that have an irrigation system on-site are defined as having a high to medium hazard rating. These require a testable backflow prevention containment device on all water supplies entering the property, regardless of the supply type or metering.

The property owner is responsible for installing, maintaining and yearly testing all backflow prevention containment devices within their property under *AS/NZS 3500.1*.

The property owner must engage a licensed plumber with backflow prevention accreditation. The backflow accredited plumber will determine what type of backflow device is required for site containment at the boundary and individual backflow devices within the property.

For more information, visit sydneywater.com.au/Plumbing/BackflowPrevention.

Irrigation system performance requirements

Irrigation systems should:

- minimise water losses through leaks
- minimise water losses through poor design and performance (Table 16)
- apply water evenly to the target area (have a high distribution uniformity)
- ensure public safety.

Irrigation Australia Limited (IAL) recommends that irrigation systems be designed, operated and maintained to achieve the minimum benchmarks set out in Table 16. (Note that lower benchmarks may be acceptable for sites that are rarely irrigated.)

Table 16 – Minimum irrigation performance requirements for open space turf areas³⁹

Category	Distribution uniformity (DU)	Non-target watering	Leaks
Sprinkler	75%	< 2%	< 2%
Subsurface drip	85%	0%	< 2%

Figure 25 – Irrigation systems must be designed by a professional



Sprinkler layout

Emitters should be laid out so that zones with different watering requirements, such as cricket pitches, field surrounds and shaded areas, can be operated independently.

To maximise water efficiency:

- ensure only the target area is watered
- ensure sprinkler heads are spaced to achieve a distribution uniformity of more than 75%. Depending on the sprinklers used, operating pressure, wind conditions and site layout, sprinklers can often be spaced at 45–75% of their throw diameters. This should be confirmed by design modelling to ensure a minimum of 75% DU is maintained
- use a triangular layout of sprinklers where possible, particularly on windy sites

- use half circle sprinklers on the perimeter of the target area
- ensure half circle sprinklers have nozzles that emit half the flow rate of the full circle sprinklers, where both types occur on the same lateral
- use matched precipitation rate (MPR) nozzles where even spacing cannot be achieved and/or when using partial arc sprinklers
- minimise the number of heads on the playing area, with sprinklers and valve boxes located away from high traffic playing areas such as goal mouths and touch lines.

Sprinkler heads should be aligned in straight lines and must be well identified to limit potential damage during turf maintenance activities, such as aeration or dethatching. The top of valve boxes should remain exposed for easy location and access.

Common problems with sprinkler heads include:

- heads get damaged through wear and tear, vandalism or mowing
- heads being replaced with different brands or styles that perform differently to the irrigation system design
- maintenance on the sports fields changing the site's characteristics, such as top-dressing reducing the relative height of the pop-up sprinkler head and therefore the clearance of the emitter from turf levels.

All of these problems reduce the efficiency and DU of your irrigation system. You should inspect and maintain your sprinkler heads regularly.

Subsurface drip irrigation systems

Subsurface drip irrigation of turf usually involves slowly applying water beneath the soil surface through polyethylene pipes that contain emitters. The advantages of subsurface drip irrigation include:

- being able to irrigate almost any time without interfering with play
- minimising surface water losses from evaporation and wind drift
- being able to irrigate with lower quality recycled water, due to the minimal risk of human contact.

Subsurface drip systems generally apply water more evenly than sprinklers. If they

are designed and installed correctly they can be water efficient. However, subsurface drip systems rely on the soil to spread water sideways. This can result in lower DU than from sprinkler systems.

Subsurface drip systems should not be installed where they will compromise renovation practices. Due to their shallow installation depth (120 – 150 mm), subsurface drip systems can limit all except the most shallow renovation techniques. If the dripline can be installed at between 250 – 300 mm, it can overcome these problems, but this is often not practical in turf systems.

Driplines are typically laid 500 – 800 mm apart, but wider spacings (and cheaper installations) can be adopted in heavier textured soils. Unfortunately, little is known about the spread of water from subsurface drip systems, so some guesswork is required in their design. Despite what some drip irrigation companies claim, water does not necessarily spread more widely in clay soils (Battam et al, 2001).

Leak detection can also be an issue with subsurface drip irrigation systems. A leak may only be observed in dry periods when a green patch forms around the area, which means that a lot of water may be wasted before the leak is noticed. If a base line flow is noticed in water monitoring data (see Benchmarking your water use – Part 4), you may

have to pull up huge sections of the drip line to find the leak.

For further information on the distribution uniformity of your subsurface drip irrigation system, check out the calculator on the Cooperative Research Centre for Irrigation Futures website www.irrigateway.net/Default.aspx.

Pressure and flow

Systems must be properly designed to have adequate flow and achieve uniform watering. Refer to AS 2032 and AS 2033 (See Appendix D) for minimum design requirements.

To ensure even sprinkler application rates, you must maintain the correct operating pressure at all times:

- Too low pressure will produce large water droplets with poor distribution.
- Too high pressure will produce very small water droplets that may drift even in the slightest breeze.

Check with your irrigation system manufacturer for your system's correct pressure and flow specifications. The best pressure setting for the sprinkler nozzle and ideal spacing can be obtained from the sprinkler performance data on manufacturers' websites.

In some irrigation systems, pumps are used to pressurise the system. It is impossible to have an efficient irrigation system if the pump is not working properly. If you notice

that the discharge of water from your irrigation emitters is low or the pressure gauges indicate low pressure, you should investigate.

Check for leaks or blockages and clean the filters before checking the pump. Pump performance will probably decrease over time. To learn more about pump performance, check the manufacturer's specifications. If necessary, visit www.irrigation.org.au to find an appropriate pump technician.

Product selection

An integral part of the design is selecting components for each element of the irrigation system. Table 17 provides minimum standards for emitters, pipes, fittings, valves, water meters, controllers and sensors.

Select your irrigation products from reputable manufacturers to ensure quality, reliability and warranty replacement. Use Smart Approved Watermark (SAWM) products where available and suitable. Industry experts have independently assessed these products as efficient.

Maintaining irrigation systems

Benchmarking your water use

Benchmarking is used by managers to measure water efficiency performance. Irrigation system benchmarking involves comparing your sports field's

water use with similar sites (see Table 2 – Introduction). Benchmarking can help you identify sites that use more water than others, or sites where water use has increased. Once you identify these sites or issues, you can develop strategies to tackle them.

To get an idea how effectively water is being used at your

site, compare historical yearly water use against the benchmarks from Table 2. The values may vary according to the type of soil, the depth of topsoil, the turfgrass type and the efficiency of your irrigation system, among other things.

The reasons why historic water use might be higher than calculated include:

- over watering
- an inefficient irrigation system (ie DU less than 75%)
- leaks.

Benchmarking exercises should be done every year so you can see the effects of seasonal changes. See Part 4 – Holistic water management, for further information.

Table 17 – Best practice selection criteria for irrigation system components⁴⁰

Device	Minimum requirements	Additional best practice requirements
Sprinkler	<ul style="list-style-type: none"> • Designed specifically for turf • Rubber top for player safety • Incorporated check valve • Matched precipitation rate nozzles 	<ul style="list-style-type: none"> • Low trajectory sprinklers on windy sites • Stainless steel risers on high wear sites • Colour coded sprinkler nozzles to enable ready identification
Dripline	<ul style="list-style-type: none"> • Incorporated anti-drain feature • Flush valves included in valve boxes • Air valve installed downstream of the solenoid valve to prevent drippers syphoning when the valves close 	<ul style="list-style-type: none"> • Dripline with impregnated root growth inhibitor to prevent blockage by roots • Pressure compensated drippers especially on sloped sites
Pipes	<ul style="list-style-type: none"> • Comply with <i>AS/NZS 1477</i> for PVC pipe, <i>AS/NZS 4765 (Int)–2000</i> for modified PVC (PVCm) and <i>AS/NZS 4130–2003</i> for polyethylene pipe • Fittings must comply with <i>AS/NZS 1477–1999</i> for PVC fittings and <i>AS/NZS 4129–2000</i> for PE fittings • Pipes distributing non-potable water have lilac stripes or approved equivalent and are marked ‘recycled water not for drinking’ 	
Control valves	<ul style="list-style-type: none"> • Flow/pressure control • Isolation valves located upstream to enable servicing of control valve • For recycled water valves should have self cleaning filters to ensure valve closes 	
In –line valves	<ul style="list-style-type: none"> • A pressure rating exceeding static pressure • Be housed in a lockable valve box • Cast iron valves must be epoxy coated 	
Water meters	<ul style="list-style-type: none"> • A submeter that only measures water used for irrigation • Pulse enabled so that a data logger can continuously record volumes used • Accurate to 2% of flow when installed and used to the manufacturer’s recommendations 	<ul style="list-style-type: none"> • Pulse output signal connected to a data logger with alarms or circuit shut off set when high flow or baseflow occurs • an electronic output that supports a remote display mounted at the controller

Fixing leaks

A very cost-effective way to save a lot of water is to fix leaks. You can find leaks in the irrigation supply main and associated valves by:

- looking for wet patches
- reading the water meter overnight, or when the facility is not in use
- using a logging device on the meter to identify a base flow.

System checks should also be performed to ensure non-target areas (eg footpaths) are not being irrigated. Sydney Water can also install data loggers on the meter for short periods at no charge, to help you confirm how much water is being lost. This also allows you to identify water use patterns and quantity of use.

Routine maintenance

The maintenance schedule should include the following checks as a minimum:

- inspecting monthly for leaks, uniform sprinkler throw, bent, broken

(eg mower damaged) or sunken sprinkler heads

- checking and recording the water meter data to compare total actual water use with the water volume expected by the irrigation schedule to identify potential leaks and/or problems with controller operation
- checking the pump station or mains connection is operating at the pressure stated in the design specifications
- testing the backflow prevention device (this must be done by a licensed plumber who is accredited in backflow prevention)
- adjusting pressure regulators to maintain design system operating pressures
- ensuring filters are operating correctly and cleaned as required
- testing the controller is operating properly and is running the correct seasonal irrigation run times and that the back-up battery is working

- testing the system sensors are working within their calibrated levels of accuracy
- checking valve adjustments to maintain proper flow and pressures
- checking sprinkler heads are properly operating and adjusted, with correct radius of throw, arc size and trajectory
- ensuring broken hardware or pipe items are repaired or replaced with the same or equivalent updated models that meet original specifications so that the entire system continues to perform as designed.

Managers should continually inspect water meter records to compare actual water use with their irrigation schedule. However, a full third-party performance audit of the irrigation system should be done every three to five years to ensure the system is working according to original design.

Competent, recognised irrigation professionals should be used to audit irrigation systems. Refer to the IAL website at www.irrigation.org.au to find a suitable certified irrigation professional in your area.

When should I water, and how often?

An irrigation schedule refers to:

- when and how often irrigation should occur
- how much water is required for each irrigation event.

Figure 26 – Irrigation should be used to maintain turf growth and condition

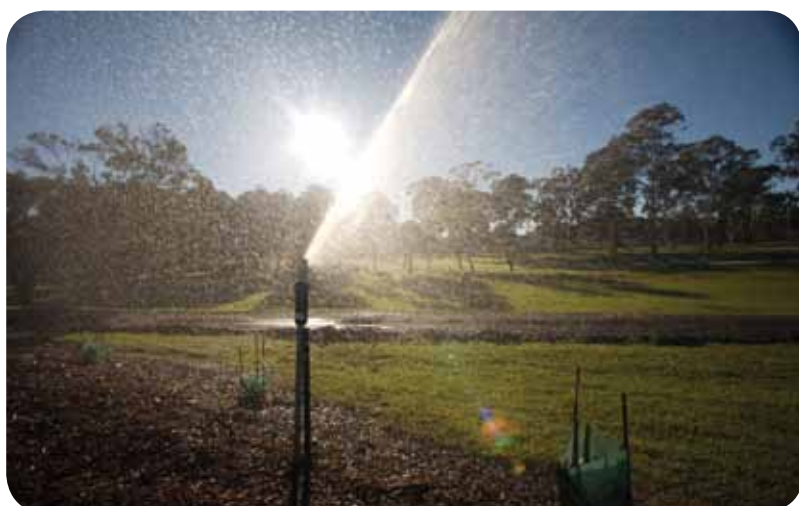

When should I irrigate?

Irrigation should be used to maintain turf growth and condition.

As water becomes less available, growth ceases and the turf will thin. Once turf has used all of the readily available water from the soil, it behaves like many other plants and may begin to shed leaves to limit further water losses (Handreck and Black, 2002).

With practice, it is possible to schedule irrigation relatively accurately, based on:

- the appearance and feel of the soil
- visual cues from the turf.

Table 18 provides a summary of physical and visual cues that indicate how wet the soil is. Once you learn how to assess the moisture condition of sports fields, you can adapt the irrigation

schedule to water only when needed. This results in better water efficiency, improved playing surfaces and cost savings.

How often should I irrigate?

You should only irrigate to supplement rainfall to meet plant water needs (McIntyre, 2004). Watering frequency will be further limited by the amount of water the soil can hold (see RAW in Part 1 – Soil).

Table 18 – How to estimate the moisture status of the soil by appearance and feel⁴¹

Moisture content	Soil	Turf behaviour
Saturated (above field capacity)	<ul style="list-style-type: none"> • Looks dark and glistens in the light • Feels cold, wet and sticks to the hand 	<ul style="list-style-type: none"> • Rapid growth unless soil remains saturated for prolonged periods • Compaction risk to soil if trampled
Field capacity (100% moisture)	<ul style="list-style-type: none"> • Looks dark and damp, but usually a matt finish • Feels cool, forms coherent ball if squeezed 	<ul style="list-style-type: none"> • Maximum growth rate • Footprints in the turf not visible for long
Just below field capacity (75 – 100% moisture)	<ul style="list-style-type: none"> • Looks dark and moist with a matt finish • Feels cool, will not form a coherent ball 	<ul style="list-style-type: none"> • Moderate growth rate • Footprints in the turf not visible for long • Does not need irrigation
Approaching wilting point (25 – 75% moisture)	<ul style="list-style-type: none"> • Looks barely damp • Feels fairly cool, hardly coheres if squeezed 	<ul style="list-style-type: none"> • Grass leaves rolled and footprint marks remain on the turf, usually overnight • Does not recover from wear, but will recover if irrigated
Wilting point (0 – 25% moisture)	<ul style="list-style-type: none"> • Looks dry • Does not feel cool and does not cohere 	<ul style="list-style-type: none"> • Grass wilted and not recovered in the morning • Footprints remain on turf • Does not recover from wear, but will recover if irrigated
Below wilting point	<ul style="list-style-type: none"> • Looks very dry • Feels warm and does not cohere 	<ul style="list-style-type: none"> • Grass wilting and dying or becoming dormant • Turf shoots do not recover when irrigated, but regrowth may occur from rhizomes of drought tolerant grasses

Allowing for rainfall

Rain influences the amount of irrigation water needed. If enough rainfall occurs, you can postpone irrigation until the soil has dried to a reasonable level. One of the difficulties in working with rainfall is estimating the fraction of total rainfall that can be stored in the turf root zone, that is, the effective rainfall.

Dealing with excess water

For optimum turf growth, the only water that should reach most open space turf areas is rainfall and scheduled irrigation (McIntyre, 2004).

Sources of excess water include:

- heavy, prolonged rain or too much irrigation
- tidal inundation
- run-off from upslope areas
- a shallow water table.

Problems of excess water can be aggravated by:

- flat sites with low infiltration
- layering within the soil profile (see Part 1 – Soil)
- an impermeable sub-base (see Part 1 – Soil).

Too much rain or irrigation

The most obvious source of excess water is from heavy, prolonged rainfall or irrigation with more water than the soil can hold.

If the soil has a low infiltration rate, the upper sections of the soil profile can remain saturated for prolonged periods

Figure 27 – Too much water can be as damaging as too little



even after relatively light rainfall or irrigation.

Tidal inundation

In low-lying areas near estuaries, open space areas can be subject to tidal inundation. This includes lower lying areas around:

- Collaroy and Neutral Bay
- Tempe
- Cooks River foreshore
- Sydney Harbour foreshore
- Lake Illawarra foreshore.

Tidal inundation also adds large amounts of salt to the soil profile. The majority of the turfgrasses used in Sydney are relatively salt tolerant. Evidence of salinity problems in turfgrasses includes loss of foliage or salt burns.

To avoid periodic inundation, turf areas should be constructed above the maximum sea level. Allowing for storm surges, the soil surface should be at least 2.3 m above the sea level as measured by Australian Datum Height (ADH) (NSW Parliament, 2006).

Flooding and run-off from upslope areas

Flood plains can be inundated by water during periods of high rainfall. Many open space turf areas are located on flood plains such as:

- Hawkesbury-Nepean River surrounds (eg Windsor, Pitt Town, Penrith and Camden)
- Lake Illawarra surrounds (eg Dapto).

Open space turf areas below or next to large impermeable areas, such as car parks, may also experience flooding from upslope run-off. Stormwater run-off from these areas can be diverted using structures such as grass swales or contour banks. The water can then be diverted into the stormwater system.

In some situations, water may enter because of sub-surface flow, with a wet spot or spring occurring on the open space turf area. This is not common and can be resolved by using a well-designed interception drain.

Some open space turf areas are also designed as flood detention basins, which means they are designed to accept excess stormwater.

A flood detention basin temporarily stores stormwater, so that it can slowly drain into the stormwater system or natural creeks. Some moisture will also infiltrate to groundwater, and some silt may be deposited on the ground. Ideally, water should drain away in 12 hours.

It is important to choose grass species tolerant of submersion for these areas. These species include couch and to a lesser extent kikuyu (which loses leaves when submerged, although its stolons persist).

Shallow water table

Shallow water tables (where the top of the saturated soil zone is less than three metres below the surface) can be present in some low-lying areas near rivers, estuaries and coastlines, including the surrounds of:

- the Hawkesbury-Nepean River
- Lake Illawarra
- the Cooks River
- estuarine and coastal areas, such as those surrounding Sydney Harbour.

Because water can rise in the soil through capillary action, the soil may remain close to saturation from 0.2 m (in sandy soils) to 2 m (in clay soils) above the water table (De Ridder and Boonstra, 1994).

To ensure free drainage of the turf growing media, the upper 0.5 m of soil should remain well aerated. This means the soil surface level above the water table height should be at least 0.7 m in sandy soils and 2.5 m in clay soils.

For sites directly adjacent to estuaries, ensuring that the turf root zone is above the capillary fringe means the soil surface should be 2.8 m and 5.3 m above sea level (ADH) for sandy and clay soils respectively.

Flat sites with a low infiltration rate

On soils with high infiltration rates such as sand profiles, excess surface water will infiltrate into the soil profile relatively rapidly.

For soils with a moderate or low infiltration rate, water can take hours or even days to infiltrate.

Soils with a low infiltration rate generally have either a high silt or clay content. This includes sandy loam, clay loam and clay texture soils.

Some very sandy soils can also have a low infiltration rate, particularly silty sands commonly sold by some soil suppliers (McIntyre, 2004).

Promoting run-off

Run-off rarely occurs on well-grassed sites with a slope of less than 1 in 100 (McIntyre, 2004). On these very flat sites ponding will occur, and surface water can accumulate in localised depressions that commonly occur on turf areas. Depressions can form as a result of:

- poor levelling during construction
- differential settlement on the soil surface (eg fields over fill sites)
- variable traffic use (eg soccer goal mouths)
- weakened turf areas (eg diseased or shallow topsoil areas)
- localised compacted depressions (eg heel prints).

A sloped surface can remove excess water from the playing surface as run-off. Steeper slopes will shed water more

Figure 28 – Possible slopes for sports field surfaces⁴²

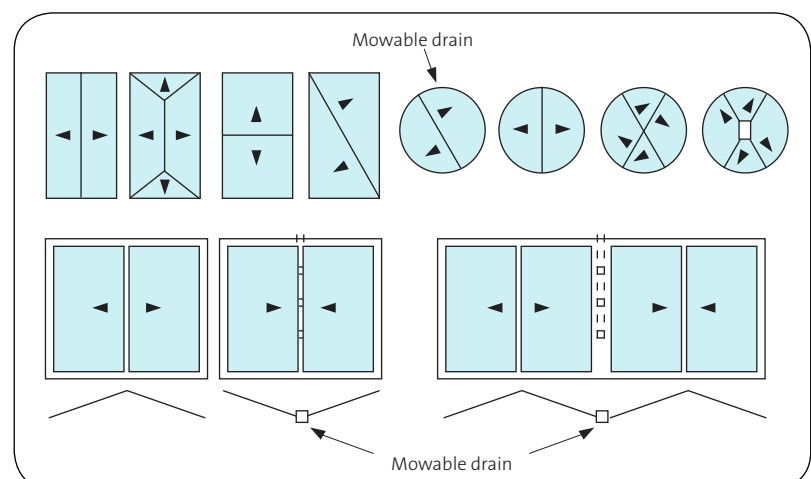

quickly, but slopes in excess of 1 in 50 are unacceptable for most sports (Adams and Gibbs, 1994).

A compromise between these extremes is suggested by McIntyre and Jakobsen (1998). They recommend a slope of 1 in 70 for a maximum of 70 m. Suitable field surface contouring patterns that can be used to ensure that slope length does not exceed 70 m are presented in Figure 28.

Subsoil drains

Subsoil drains are sometimes installed under sports fields to drain ground water.

The effectiveness of these drains depends greatly on the permeability of the subsoil (Marshall et al, 1996). If impermeable clay subsoil is only 300 mm below the surface, drains must be spaced less than two metres apart to remove excess water from the upper 100 mm of topsoil in 24 hours.

The topsoil on many turf areas is less than 300 mm deep. Therefore, in most

situations, subsoil drains are not effective if spaced more than about 1.5 m apart (McIntyre, 2004).

It is far more important to ensure the subsoil has a drainage rate of over 1 mm/hr, (McIntyre, 2004) than to install an expensive subsoil drainage system.

Grate drains

Grate drains can be used to capture surface water flows, but these are more suited to areas away from where sporting activities occur.

Sand slit drains

Sand slit drains can be installed into the existing soil profile by specialised machines. These can be filled with sand over a layer of gravel, or with a small-diameter pipe installed in the bottom of the drain. The slit drains can either link to sub-surface pipe drains, or carry the water off the playing surface. If the slit drains have to carry water more than a few metres, then a pipe in the slit drain is essential.

An experienced drainage contractor or consultant can calculate the appropriate rate of water removal from a sports field.

On the playing surface, slit drains can be used to capture surface water flow (Figure 29). The steepness of the slope in Figure 29 has been exaggerated for visual clarity.

For slit drains to effectively capture run-off, it is crucial that the sand extends all the way to the soil surface. Turf containing fine soil material should not be laid over the slit drain. Instead, re-establish turf growth over the slit drain using washed turf (from a turf farm with soil removed), vegetative propagation, seed or regrown turf from nearby areas.

Slit drains are usually spaced two metres apart (McIntyre, 2004), but narrower spacings are sometimes used. If a wider spacing is used, a wider trench width is required, which may cause striped turf.

Following the construction of slit drains, it is common practice to top-dress the site with pure sand. While top-dressing with sand may be appropriate on sites that have drainage in or through the profile, it can reduce the amount of surface run-off, potentially aggravating waterlogging problems in surfaces where water cannot drain away.

Suitable top-dressing material for slit drains should be selected on a site-by-site basis.

Figure 29 – Cross section of slit drains⁴³

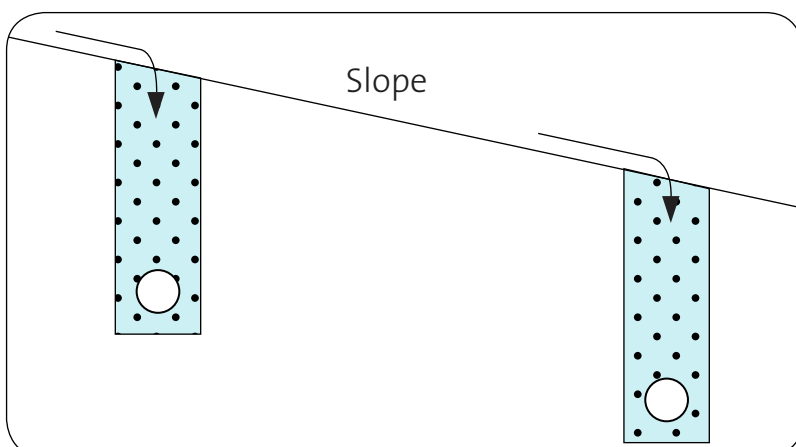

Options include:

- top-dressing with sand to create a ‘sand carpet’ that maintains unimpeded pathways for water to infiltrate from the surface into the slit drains. The sand carpet should not exceed 75 – 100 mm in depth or the surface can become excessively dry
- top-dressing with a soil closer in texture or only slightly sandier than the underlying soil, but ensure the top-dress has a high saturated hydraulic conductivity
- top-dressing with a soil closer in texture or only slightly sandier than the underlying soil, but periodically sand groove to restore the link between surface and slit drains.

Sand grooving

Sand grooving involves backfilling sand into 20 mm wide grooves that extend from the surface to a depth of 100 – 250 mm. Sand grooves are typically 150 – 200 mm apart and unlike slits there is no drainage pipe installed in the base of the narrow ‘trench’.

Lateral water movement occurs very slowly in the base of sand grooves, even though it occurs through sand. To ensure excess water is conveyed off-site as quickly as possible, high quality sand should be selected and the sand grooves must be interconnected with the slit drainage system at 2 – 5 m intervals.

Case study – Waterlogging at Birchgrove Oval⁴⁴

Birchgrove Oval acts as a drainage sink, collecting water from the surrounding slopes. This water pools on the surface of the playing field, compacting the topsoil and decreasing turf performance.

A site assessment found that waterlogging was caused by:

- existing layering and compaction in the upper sections of the soil profile
- poor surface relief
- trees shading the area that gets water run-on from surrounding slopes.

It was recommended that deep renovation works (eg ‘earthquaking’ or deep slicing – see Table 5) be done to address the soil layering and compaction problems. This, however, should be done as preventative maintenance, and only when the waterlogged field is dry.

Together with deep renovation works, installing a surface or slit drain was recommended to intercept the water before it reaches the sports field.

Along with regular aeration and decompaction, avoiding unnecessary inundation with water is vital to keeping a field green and healthy.

Figure 30 – Waterlogging problems caused by top-dressing with sand⁴⁵



Part 3 – Irrigation and drainage endnotes

37. Mick Battam

38. Mick Battam

39. Tony Spinks, Rohan Brown and Mick Battam

40. Tony Spinks and Rohan Brown

41. Source : Sydney Environmental and Soil Laboratory Pty Ltd

42. From McIntyre, 2004

43. From McIntyre, 2004

44. Joshua Ryan and Mick Battam

45. Mick Battam





Part 4

Holistic management

Contributors: Tony Spinks, Rohan Brown, Tim Gilbert, Mick Battam, Peter Martin, Steve Garland, Jim Hull, Annie Kavanagh, Simon Leake, Basant Maheshwari

The key to healthy turf

Holistic management is the key to a healthy, fit for purpose turf area. Management practices should combine knowledge in all elements of open space turf management, including soil, turf, irrigation practices and appropriate patronage.

Managing increased foot and vehicle traffic

Australia's population is expected to grow to nearly 36 million by 2050 (Commonwealth of Australia, 2010). Most of this growth will be concentrated in capital cities. Sydney's population is forecast to grow from 4.5 million (2010) to 6 million by 2050.

This huge increase in population will place heavy pressures on all forms of urban infrastructure, including water supply and open spaces. This means increased use of sports fields, parks, ovals and golf courses.

Increasingly high traffic loads will put additional pressure on open space managers to maintain adequate turf coverage. The struggle to maintain turf coverage will result in greater use of water and nutrients.

To overcome problems of excessive traffic loads, open space managers can:

- avoid using open space turf areas as car parks

- reduce traffic loading on the field in winter by moving training to an alternative site
- establish a user limit to define the maximum hours of play your field can support (see Figure 31)
- rotate play to different areas of the field, reducing wear on high traffic areas such as goal mouths
- oversow with ryegrass to help turfgrass recover during cooler months (though timely and thorough removal of ryegrass is required in spring)
- rest the field at the end of the winter sport season so it can recover
- investigate 'new generation' synthetic surfaces.

The best way to manage traffic on your open space turf area is to maintain open and honest communications with local sporting clubs. Some councils in Sydney have grounds checklists that sporting clubs must complete each weekend of play. Checklist scores are

allocated to problem areas, such as surface water, grass cover and surface level, and an excessive score leads to cancellation of play.

Figure 31 depicts the impact that soccer has on a couch sports field at Five Dock, based on the maximum carrying capacity as shown by the blue line (model developed by Dr Mick Battam). Between June and August, 20 hours of soccer will cause excessive wear on the goal keeper's box and infield, while the turf in the outfield is able to handle the traffic loads.

Monitoring water use

Monitoring water use regularly is the key to maintaining a successful open space management program.

Saving water is easier if you know how much water you are using, as well as where and when it is being used. Measuring these factors will help you find your best opportunities to improve irrigation efficiency.

Figure 31 – Are traffic loads sustainable?⁴⁶

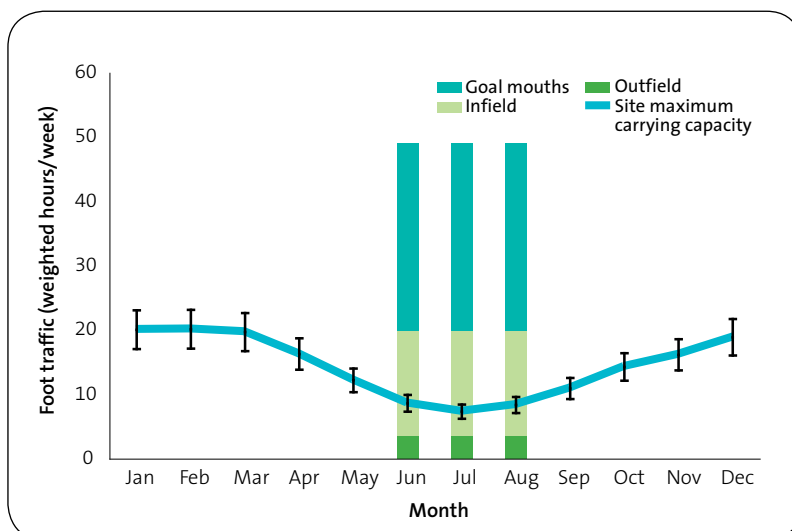

Setting water management goals

Before monitoring, set water management goals for individual parks and playing fields. Table 2 – Introduction shows water use benchmarks for open space turf areas, however we still recommend that you contact an expert to help you develop a more detailed benchmark (see ‘Where to find a qualified consultant’ on page 76).

Water management goals help you compare the monitored water use and indicate how well you are travelling. You can also determine whether or not there is further scope for improvement.

An example of setting water management goals can be found in the IPOS Code used by South Australia Water (www.sawater.com.au/SAWater/Environment/WaterRestrictionsConservationMeasures/IPOS.htm). An estimated Base Irrigation Requirement is set for the irrigated turf area. (This tool is specific to South Australia and may not be transferable to Sydney.)

Monitoring – the key to identifying water efficiency

Monitoring will help you understand your water use patterns, and identify inefficient practices. Monitoring is also the best way to identify leaks that could otherwise remain

undetected, costing you unnecessary water charges.

There are three main ways to monitor your water use:

1. Manual meter readings.
2. Offline monitoring systems.
3. Online monitoring systems.

Meters often cover facilities other than your irrigation system, such as a toilet block. To gain more detailed irrigation information from your monitoring, you can install a submeter. Your submeter should be located on the main irrigation line so only irrigation water use is measured. Figure 32 shows the typical location of a submeter on an irrigation system with a storage tank and without a storage tank.

Figure 32 – Typical locations to install a submeter on an irrigation system

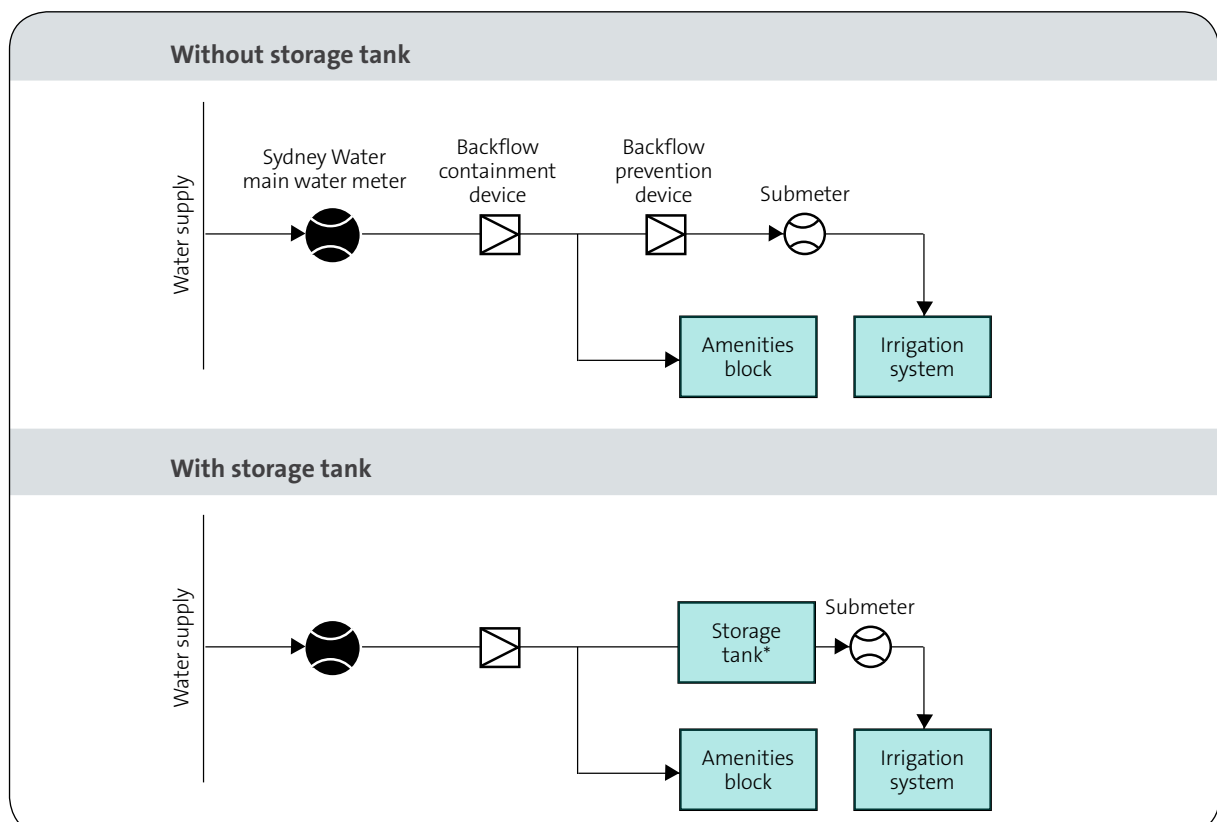

* Storage Tank to meet the AS/NZS 3500.1 requirements for a registered break tank

Manual meter reading

Your Sydney Water bill shows your water use each quarter. However, you can read your own meter more often – weekly or even daily.

To check if your irrigation system has leaks, take a meter (or submeter) reading at the start of consecutive days. If there is a difference between the meter readings taken on each of these days, and there was no irrigation event or any other water use at the site in the preceding 24 hours, you may have a leak.

How to read your meter

Most water meters have a series of numbers. The numbers measure the amount of water used in kilolitres and litres. The numbers in black measure kilolitres (thousands of litres) and the red numbers measure fractions of a kilolitre.



Figure 33 – Read your meter as part of your routine maintenance program

Standard water meters may have a series of six, seven or eight numbers. Examples of how to read these meters are given in Figure 34.

1	2	3	4	5	6	7	8
---	---	---	---	---	---	---	---

Black numbers measure kilolitres (kL), thousands of litres.

Red numbers measure fractions of kilolitres.

The above example totals 12,345.678 kilolitres.

Or

12,345 kilolitres and 678 litres

Figure 34 – How to read a standard water meter

Large water meters may break down water use even further by using dials and a series of numbers. One example of how to read a large water meter is shown in Figure 35. If your water meter is different and you are having trouble reading it, contact the meter manufacturer for detailed meter reading instructions.

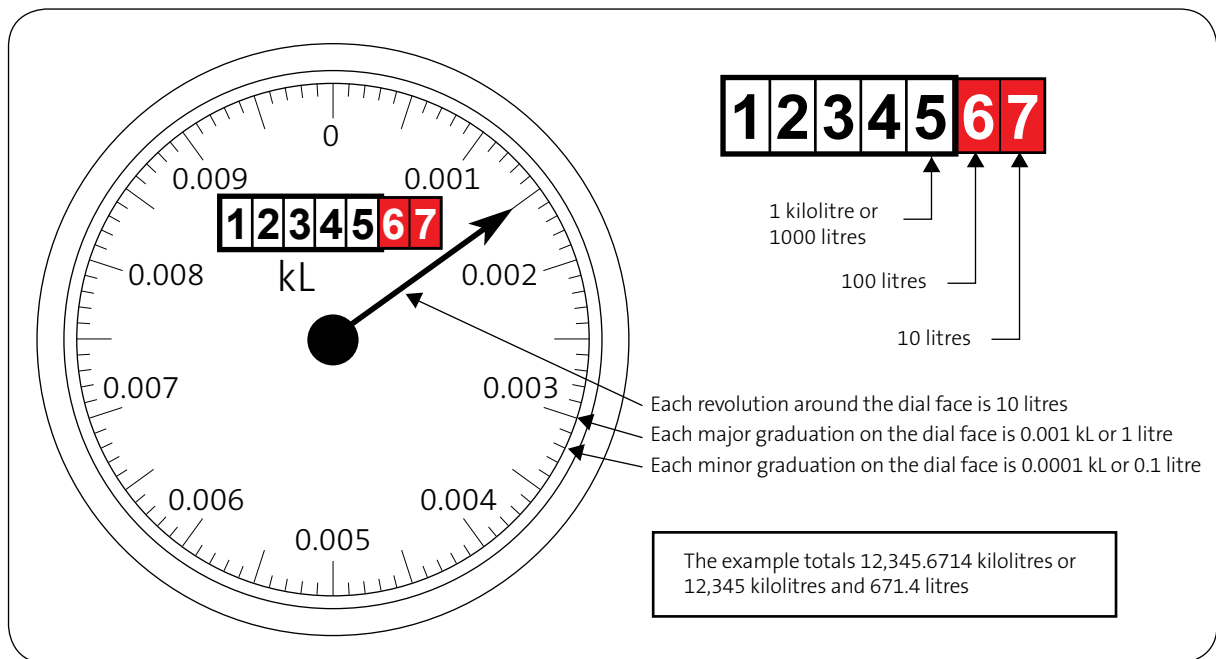

Figure 35 – How to read a large water meter

DIY monitoring systems

Installing a water data logger on your water meter is a more efficient way to monitor water use. Water data loggers monitor water use frequently – generally between every five and fifteen minutes. This saves you time and readily identifies water use patterns and water waste.

Data loggers fitted to your meters or submeters collect information on water use. The data must be manually downloaded to a laptop regularly, so it can be analysed.

These systems are relatively inexpensive and give good information. You can also

swap the loggers from site to site. However, because data is not relayed to your computer automatically, you will need to download and analyse it. This can be time consuming, so it can still take a while to detect leaks.

Sydney Water has more information about data loggers that can be used to monitor water use. Contact the water efficiency section at sydneywater.com.au to find out more.

Online monitoring

You can pay a company to install data loggers and give the information to you.

Some provide information immediately through the internet. They can also set an alarm to alert you by email or SMS, if there are any dramatic changes in water use or increases in base flow.

To establish an online monitoring system for your open space turf areas, you will need to pay an upfront cost to set up the system and a smaller yearly service charge. The cost to install and operate continuous online monitoring could be offset by savings in water, equipment maintenance and upgrades. Contact Sydney Water for more information.



Figure 36 – Data loggers can be easily installed and used



Figure 37 – By attaching a data transmitter to a water meter, you can send data to a website

Leaks and base flows

Leaks are visible or hidden and occur when water is lost through cracks or faulty components in the plumbing system. Leaks are either static or pressure.

- Static leaks have a constant loss of water
- Pressure leaks are caused by a pressurised system when the system is operating.

Base flow is overnight or unaccounted for water use identified by monitoring. This could mean a concealed leak.

Figure 39 shows a site water use monitoring profile where a base flow has been identified. The monitoring time line helps to narrow down the cause of the base flow. The flow never returns to zero – even overnight when no irrigation is occurring.

Visible leaks

Visible leaks in open space turf areas can occur in:

- amenities blocks
- irrigation system components that are above ground
- sprinkler heads
- sprinkler nozzles.

Ask your grounds staff to report leaks if they see them. Leaks can cost thousands of dollars a year if they are not identified quickly.

Hidden leaks

Some leaks are not visible and hard to detect. This can be due to complex underground irrigation networks that make it hard to identify, locate and repair leaks.

Common indications of a leak in the irrigation system could include:

- soggy or patchy green grassy areas
- steady flows in drain lines
- a larger water bill than normal

- puddles on the sports field, which have not been caused by other factors
- the water meter is registering water use when the irrigation system is not in use.

To help identify leaks, it is best to ensure that your meter only records irrigation water use. If other amenities are also registered by the meter, you should install a submeter to accurately monitor irrigation water use.

Central control systems

Central control systems can help you save water because they can receive information about soil moisture, rainfall and temperature and use it to adapt the irrigation schedule.

Basic irrigation controllers are used in some open space turf areas, but are not always appropriate. Replace them if they cannot manage the irrigation schedule required for a site. For example, they may not be able to set sprinkler systems to water less than once a week.

Central control allows the operator to access the control programs of a number of satellite controllers from a central point, where those satellite controllers are either hard-wired or remotely connected to the central control by telephone or radio link. Central control is particularly useful where the operator is managing multiple irrigation sites.



Figure 38 – Green patches in turf can indicate a leak in the irrigation system

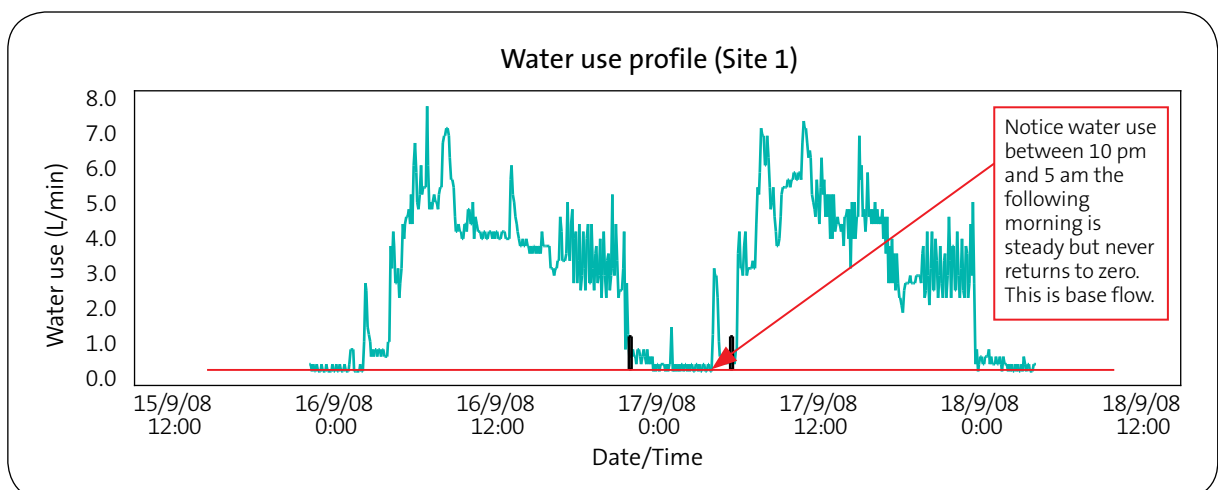

Figure 39 – Site water use monitoring profile indicating a base flow

Figure 40 – An holistic approach is the key to water management



Most commonly, the central point is a computer-based program and interface but can also be a wall-mounted master controller located at one irrigation site. The sophisticated nature of this form of control allows, in most cases, communicating with multiple sensors and weather stations resulting in the ultimate control facility for irrigation systems.

The features available with computer-based systems are many and varied and are being upgraded regularly. Some particularly useful computer-based features are:

- on-screen display – graphic display of the system in operation
- on-screen control – manual operation of individual valves from the computer screen
- real time feedback – from the operating valves, controllers/decoders and pump stations
- irrigation cost calculations – calculate energy and operation costs

of irrigation from flow monitoring and irrigation event logging to assist in budgeting

- weather station and pump station control – sophisticated weather station and pump control software and sensors
- wireless control of sprinklers.

Lighting can also be linked to the central control system. This has the added advantage of monitoring energy use, and allowing you to control foot traffic on your open space turf areas at night.

Rain sensors

Almost all irrigation controllers can be connected to a rain switch to prevent irrigation during or immediately following rain. Many rain switches are adjustable, and irrigation can be stopped following 6, 13, 19 or 25 mm of rain.

Most rain switches reset within 4 –24 hours of being triggered. To ensure watering events do not occur too soon after rain,

two options are available:

1. Buy a control system that allows the operator to program a longer delay following a rainfall event. (This feature is only available with some controllers.)
2. Buy a rain sensor with an adjustable reset and locate the sensor in a shaded location, so it takes longer to dry out and reset.

A control system that delays irrigation events after rainfall can significantly reduce water use.

Rain gauges

Central control systems can also be connected to a rain gauge that measures the quantity of rain that has fallen.

Yearly water savings of 1 –2.5ML a hectare can be achieved, if rainfall information is entered into an appropriate irrigation control system (Mick Battam, unpublished data).

Soil moisture sensors

Soil moisture sensors measure the water available in the soil. They can be connected to irrigation controllers so that irrigation occurs when soil is dry and prevented when it is wet.

When they are connected to a stand-alone controller, they can generally only alter the length of an irrigation event.

Dielectric or time domain sensors are generally considered more reliable than older style electrical conductivity sensors.

Variations in microclimate, topsoil type and depth and type of use can make it difficult to determine a suitable sensor location on active sports fields. For example, a soccer field may have:

- a variable microclimate (eg shading from spectator stands)
- variable soil (eg cut and fill site with poor soil mixing)
- variations in turf type and cover
- areas with high (goal mouth, centre strip) and low (sidelines) amounts of foot traffic.

At any one site, soil conditions can vary considerably, limiting the accuracy of soil sensors.

Soil sensors are also very sensitive to the installation method. If the soil sensors are installed too shallow or not clearly marked, they can be damaged when topsoil is being renovated.

Wind, frost and flow sensors

Irrigation controllers can also be connected to sensors that prevent irrigation during high wind, frost or high water flow (which may occur if a sprinkler is broken). Like rain sensors, these sensors essentially act as on/off switches that can be set at different levels.

Using computer models for irrigation

There are computer programs that can help you manage irrigation on multiple sites. Every approach depends on assumptions and input data. Regardless of the method, you choose, you should seek advice from experts that have appropriate industry qualifications, certification

and years of experience, and directly observe how your turf responds to any management changes. You can find more information at:

- Irrigation Australia (www.irrigation.org.au)
- The Cooperative Research Centre for Irrigation Futures (www.irrigationfutures.org.au).

Using weather forecasts

In summer, irrigation should be programmed according to weather forecasts. Irrigation can be brought forward to occur before hot and windy days when evaporation is higher. This helps to reduce stress damage to turf. Irrigation should be delayed if rain is forecast.

Example⁴⁷: A sports field is programmed to be irrigated every Thursday

Issues: Temperatures of 42°C are forecast for Wednesday with dry westerly winds

Solution: Bring forward the irrigation to Tuesday afternoon to minimise the likelihood of extreme water stress and subsequent loss of turf quality on Wednesday.

Figure 41 – Typical automatic weather station⁴⁸



Other ways to estimate irrigation demand

Pan evaporation data

Pan evaporation is a traditional method for scheduling irrigation and remains a common benchmarking tool. Pan evaporation varies throughout Sydney and is dependent on local climatic conditions. Industry experts now question the accuracy of using pan evaporation/crop factors as a data source, instead using deficit or water balance models.

The Bureau of Meteorology measures pan evaporation losses at six locations in Sydney (see Table 19). Average daily pan evaporation at Observatory Hill is only 72% of pan evaporation at Riverview (Lane Cove), despite being only 6 km away. These differences are difficult to explain given both of these stations record similar humidity, wind speed and radiation. The differences are probably due to localised effects, highlighting the problems of using pan evaporation.

Automatic weather stations

If open space managers need accurate, frequent, site-specific data they may be interested in purchasing and installing an automatic weather station (AWS) through the Australian Bureau of Meteorology. An AWS provides information including rainfall, air temperature and pressure, humidity, wind speed and wind direction. Information is available at www.bom.gov.au/inside/services_policy/pub_ag/aws/aws.shtml.

Modelling using historical weather data

Yearly irrigation requirements for open space turf areas can be estimated using historical weather data.

At least 15 years of daily data is needed for accurate calculations. Twenty-five years of daily data is better, but having data for this extended period is not always realistic. Sufficient historical daily data is available for some locations in Sydney, including Sydney Airport, Sydney Botanic

Gardens, Observatory Hill and Centennial Park. More detailed information on historical data can be found at www.bom.gov.au/climate/data/index.shtml.

Daily data is needed because monthly data can underestimate irrigation needs. For example, in a relatively dry January, 48 mm of rainfall was recorded at Sydney Airport, suggesting that most sports fields in the area would need little irrigation. However, all of this rain fell during the first few days of the month. Due to the limited amount of water that soils in the area can capture, many sites would still require irrigation 5–14 days after this large rainfall event.

Rainfall information for Sydney is available from:

- www.weather.com.au/nsw/sydney
- www.bom.gov.au/hydro/flood/nsw/sydney_metro.shtml.

Table 19 – Average climatic conditions in December for the Sydney area⁴⁹

Pan station	Pan evaporation (mm/day)	Radiation MJ/m ² /day	3 pm temperature (°C)	3 pm relative humidity (%)	3 pm wind speed (km/hr)
Sydney Airport	7.5	24.0	23.8	58	25.1
Observatory Hill	4.4	23.6	23.8	59	19.5
Riverview	6.1	23.5	23.5	60	18.2
Prospect	5.8	23.4	25.9	49	14.5
Badgerys Creek	6.5	23.2	26.4	48	18.9
Richmond	7.0	23.0	26.9	48	15.6

Alternative water sources

Alternative water sources can be a good substitute for drinking water. You should first minimise your demand

for water by following the advice in these best practice guidelines, before seeking alternative water sources. This will enable you to minimise capital and operating costs that may otherwise be

incurred from oversizing components for alternative water supplies, such as pipes, storages and pumps.

Table 20 outlines alternative water sources:

Table 20 – Alternative water sources for open space turf irrigation

Alternative water source	Explanation	Useful resources
Rainwater	Run-off water from roofing	NSW Health Private Water Supply Guidelines 2008, <i>Use of Rainwater Tanks Where a Public Water Supply is Available</i> , www.health.nsw.gov.au EnHealth: <i>Guidance on the use of rainwater tanks, 2004</i> , www.enhealth.nphp.gov.au
Stormwater	Run-off water from footpaths, roads and car parks that typically flows away from urban areas through drains or creeks, but is sometimes detained in ponds	The Australian Environment Protection and Heritage Council is developing national guidelines for stormwater harvesting and re-use, www.nepc.gov.au
Recycled water	Treated wastewater from a wastewater treatment plant. Some recycled water can be used directly from the plant. Other types may require further treatment, depending on the type of irrigation and other controls in place	sydneywater.com.au Recycling guidelines at www.waterforlife.nsw.gov.au Environmental Protection and Heritage Council (EPHC): <i>National Water Quality Management Strategy – Australian Guidelines for Water Recycling: Managing Health and Environmental Risks (Phase 1) – November 2006</i> , www.ephc.gov.au
Sewer mining	Effluent extracted from a wastewater main and treated on-site before use	sydneywater.com.au
Groundwater	Extracted from aquifers. Refer to NSW Office of Water for information on how to apply for a licence to extract groundwater	The Department of Environment, Climate Change and Water regulates groundwater in NSW, www.environment.nsw.gov.au NSW Office of Water, www.water.nsw.gov.au

Figure 42 – A qualified consultant can advise on one or many aspects of turfgrass management



Alternative water sources can be costly compared to drinking water. The real cost of alternative water should include:

- type and length of pipe required with ancillaries (including valves, joints, meters etc)
- pumps and pump fixtures
- type of treatment
- energy / power supply
- operating and maintenance cost.

Before deciding to go ahead with an alternative water scheme, have a specialist conduct a feasibility study to determine whether your site(s) is suitable.

Where to find a qualified consultant

There are many consultants who can provide quality advice on one or more aspects of turfgrass management. Before engaging a consultant, check that they have the appropriate qualifications and industry certification. Use consultants with higher levels of industry certification for more expensive or sensitive works such as drainage design.

Suitable contacts that provide advice or work on open space areas can be obtained from:

- various universities around Sydney

- the Irrigation Australia website (www.irrigation.org.au), which lists suppliers and contact details for expert certified irrigation professionals
- the Australian Institute of Agricultural Science and Technology (AIAST), or their subsidiary (Australian Association of Agricultural Consultants), who can provide contacts for soil consultants.

Fact sheets and reports on turf management are available from:

- Horticulture Australia (HAL) www.horticulture.com.au
- Department of Climate Change and Water (DECCW) www.environment.nsw.gov.au.

Learn more – other resources for sports field management

There is a wealth of literature available on constructing and maintaining turf surfaces. Resources include books, magazines, websites, scientific journals and reports. The quality of the literature ranges from peer-reviewed scientific journals, such as the

International Turfgrass Society Research Journal, to websites that peddle some dangerous and ill-informed opinions. It is the responsibility of turfgrass managers to use the available information wisely.

There are some extremely well-regarded guidelines on selecting sports field soils, constructing soil profiles, designing drainage and performance testing existing soil profiles (eg publications of Keith McIntyre in the ACT, the Sports Turf Research Institute (STRI) in the UK, and the United States Golf Association (USGA) in the USA). These publications provide guidance to those who plan or maintain sports turf surfaces.

Research has been conducted by the USGA green section, the STRI in the UK, and the American Society of Testing and Management. Results have been published in various books, papers, and on websites. Additional research has been conducted by other organisations such as the New Zealand Turf Research Institute, the Australian Golf Course Superintendents Association, the Australian

Turf Research Institute (now defunct), the Queensland Department of Primary Industries and others.

Training for sports field managers and workers is available through TAFE to diploma level, and through universities to degree and post-graduate level. In addition, specific training courses such as Chemcert and Smart-train are offered by TAFE and private providers. IAL also has its Irrigation Efficiency Course and a recognised training course, which can lead to Statement of Attainments for Units of Competency recognised under the national training framework.

Part 4 – Holistic management endnotes

46. Mick Battam

47. Mick Battam

48. Parkland Irrigation Pty Ltd

49. Source: Australian Bureau of Meteorology



A large, dense green tree with a thick trunk stands on a well-maintained green lawn. In the background, several tall palm trees are visible against a clear blue sky. The scene is bright and sunny, suggesting a tropical or subtropical environment.

Appendix

**Checklists, tables, glossary
and bibliography**

Appendix A

Weeds commonly found in Sydney open space turf areas and their major growth periods.

Common name	Botanical name	Jan	Feb	Mar	Apr	May	Jun	Jul	Aug	Sep	Oct	Nov	Dec
Annual ryegrass	<i>Lolium rigidum</i>												
Annual veldt grass	<i>Ehrharta longiflora</i>												
Barley grasses	<i>Critesion spp.</i> (= <i>Hordeum spp.</i>)												
Barnyard grasses	<i>Echinochloa spp.</i>												
Crabgrass	<i>Eleusine indica</i>												
Goosegrass	<i>Eleusine trystachya</i>												
Parramatta grass	<i>Sporobolus</i>												
Paspalum	<i>Paspalum dilatatum</i>												
African Lovegrass	<i>Eragrostis curvula</i>												
Summergrass	<i>Digitaria sanguinalis</i>												
Wintergrass	<i>Poa annua</i>												
Kikuyu	<i>Penisetum clandestinum</i>												
Couch	<i>Cynodon spp.</i>												
Pigeon grass	<i>Setaria spp.</i>												
Prairie grass and related sp.	<i>Bromus spp.</i>												
Rat's tail fescue, Silver grass	<i>Vulpia spp.</i>												
Rhodes grass	<i>Chloris guyana</i>												
Wallaby grasses	<i>Danthonia spp.</i>												
Water couch	<i>Paspalum distichum, P. paspaloides</i>												
Yorkshire fog grass	<i>Holcus lanatus</i>												

		Common name	Botanical name	Jan	Feb	Mar	Apr	May	Jun	Jul	Aug	Sep	Oct	Nov	Dec
Broadleaf weeds	Bindii	<i>Soliva pterosperma</i>													
	Burr-medic, and related medics	<i>Medicago spp.</i>													
	Capeweed	<i>Arctotheca calendula</i>													
	Catsears	<i>Hypochoeris spp.</i>													
	Chickweed	<i>Stellaria media</i>													
	Clovers	<i>Trifolium spp.</i>													
	Cotula, Carrot weed	<i>Cotula australis</i>													
	Creeping buttercup	<i>Ranunculus repens</i>													
	Creeping oxalis	<i>Oxalis corniculata</i>													
	Dandelion	<i>Taraxacum spp.</i>													
	Fleabane	<i>Conyza bonariensis</i>													
	Hydrocotyl, Pennywort, Pennyweed	<i>Hydrocotyle spp.</i>													
	Khaki weed	<i>Alternanthera pungens</i>													
	Mallows	<i>Malva spp.</i>													
	Mouse ear chickweed	<i>Cerastium glomeratum</i>													
	Plantains	<i>Plantago spp.</i>													
	Starweed, Field madder	<i>Richardia stellaris</i>													
	Creeping speedwell	<i>Veronica persica</i>													
	Spiny emex	<i>Emex australis</i>													
	Wireweed	<i>Polygonum aviculare</i>													
Sedge and rushes	Mullumbimby couch, Kyllinga	<i>Cyperus brevifolius</i>													
	Nutgrass	<i>Cyperus rotundus</i>													
	Onion grass, Guildford grass	<i>Romulea rosea</i>													
	Onion weed	<i>Nothoscordum gracile</i>													
	Toadrush	<i>Juncus bufonius</i>													

+ Although many weeds are shown having times of low impact, they are often perennial weeds that have periods of dormancy or very slow growth, eg Parramatta grass is a true perennial, though it grows at a negligible rate in the winter months.

■ denotes flowering period of weed

Appendix B

Pests commonly found damaging turf in the Sydney region and their season of greatest impact.

	Common name	Scientific name	Jan	Feb	Mar	Apr	May	Jun	Jul	Aug	Sep	Oct	Nov	Dec
Root feeding insects and nematodes	African Black Beetle	<i>Heteronychus arator</i>												
	Black-headed cockchafer	<i>Aphodius tasmaniae</i>												
	Mole crickets	<i>Gryllotalpa and Scapteriscus spp.</i>												
	Ground Pearls	<i>Margarodes spp.</i>												
	Plant pathogenic nematodes	Various species												
	Red-headed cockchafer	<i>Adorophorus couloni</i>												
Stem and leaf chewing insects	Argentine scarab	<i>Cyclocephala signaticollis</i>												
	Argentine Stem Weevil	<i>Listronotis bonariensis</i>												
	Armyworms	<i>Aspödoptera mauritia</i>												
	Billbug (La Plata Weevil)	<i>Sphenophorus brunipennis</i>												
	Couch fly, Couchtip maggot	<i>Delia urbana</i>												
	Cutworms	<i>Agrotis spp.</i>												
Sod Webworms	<i>Herpetogramma licarsialis</i>													
Sucking pests	Couchgrass mite	<i>Eriophyes cynodoniensis</i>												
	Couchgrass scale	<i>Odonaspis ruthae</i>												
	Spider mites	<i>Tetranychus spp.</i>												
Other pests	Earthworms	Various species												
	Funnel ants	<i>Aphaenogaster pythia</i>												

Appendix C

Common turf diseases in the Sydney region and their season of greatest impact.

	Common name	Scientific name	Jan	Feb	Mar	Apr	May	Jun	Jul	Aug	Sep	Oct	Nov	Dec
Foliar diseases	Dollar Spot	<i>Sclerotinia homeocarpa</i>												
	Downy Mildew	<i>Sclerophthora macrospora</i>												
	Grey Leaf Spot	<i>Pyricularia grisea</i>												
	Leptosphaerulina Leaf Blight	<i>Leptosphaerulina spp.</i>												
	Red Thread	<i>Laetisaria fuciformis</i>												
	Rust	<i>Puccinia spp.</i>												
Foliar and/or leaf diseases	Anthracnose	<i>Colletotrichum spp.</i>												
	Brown Patch	<i>Rhizoctonia solani</i> and usually other pathogens												
	Curvularia	<i>Curvularia spp.</i>												
	Fusarium Patch	<i>Microdochium nivale</i>												
	Helminthosporium diseases	<i>Bipolaris, Dreschlera</i> and <i>Exserohilum spp.</i>												
	Kikuyu Yellows	<i>Verrucalvus flavofaciens</i>												
	Leaf Spot	<i>Dreschlera poae</i>												
	Pythium Blight	<i>Pythium spp.</i>												
	Pythium Root and Crown Rot	<i>Pythium spp</i>												
	Rolf's Disease	<i>Sclerotium rolfsii</i>												
Root diseases	Spring Dead Spot	<i>Leptosphaeria korrae</i>												
	Summer Patch	<i>Magnaporthe poae</i>												
	Take all patch	<i>Gaeumannomyces graminis var. avenae</i>												
Non-infective diseases	Algae	<i>Nostoc, Oscillatoria, Chlamydomonas, and Anabaena spp.</i>												
	Fairy Ring	Various <i>Basidiomycetes</i>												
	Slime molds	Various <i>Myxomycetes</i> including <i>Physarium cinerium</i>												

Appendix D

Existing standards and guidelines for irrigation system design.

The irrigation and drainage section of these best practice guidelines should be read in conjunction with the following guidelines and standards:

- *Urban Irrigation: Best Management Practices May 2006* (Water Services Association of Australia, The Irrigation Association of Australia Ltd)
- *Australian Guidelines for Water Recycling: Managed Aquifer Recharge and Stormwater Harvesting and Re-use Guidelines for the use of recycled or reclaimed water in open space irrigation.* National Resource Management Ministerial Council, Environment Protection and Heritage Council, and the National Health and Medical Research Council
- *AS 1477 – 1999 PVC pipe and fittings for pressure applications*
- *AS 2032 – 2006 Installation of PVC pipe systems*
- *AS 2033 – 1980 Installation of polyethylene pipe systems*
- *AS/NZS 2566.2 – 2002 Buried flexible pipelines*
- *AS 2698 Polyethylene pipe for irrigation*
- *AS 2845.2 – 1996 Water supply – Backflow prevention devices*
- *AS/NZS 3500 – 2004 Plumbing and drainage*
- *AS 4130 – 2009 PE pipes for pressure applications*
- *AS/NZS 4765 – 2007 Modified PVC (PVC-M) pipes for pressure applications*
- *NSW Code of Practice – Plumbing and Drainage 2006.* Committee on Uniformity of Plumbing and Drainage Regulations in NSW (CUPDR)
- *Managing Urban Stormwater: Harvesting and Re-use.* Department of Environment and Climate Change, Parramatta, 2006.

Appendix E

Checklist

Each question should not be looked at in isolation. Soil, turf, irrigation and drainage features can all affect the recommended actions for a sports field. For a more detailed analysis, consult an expert.

Open space turf area	BPGs reference	Things to consider	Notes
What is my category of open space?	Introduction Table 2 Page 9	My field is classified as: <input type="checkbox"/> Elite <input type="checkbox"/> Regional <input type="checkbox"/> Local <input type="checkbox"/> Passive	The category of open space will determine what your management practices might be and how much water you use.
Soil			
What is my typical soil texture?	Part 1 Figure 2 Page 12	My soil texture is: <input type="checkbox"/> Sand <input type="checkbox"/> Loamy sand <input type="checkbox"/> Sandy loam <input type="checkbox"/> Sandy clay loam <input type="checkbox"/> Sandy clay <input type="checkbox"/> Clay loam <input type="checkbox"/> Clay <input type="checkbox"/> Silty Clay <input type="checkbox"/> Loam <input type="checkbox"/> Silty clay loam <input type="checkbox"/> Silt loam <input type="checkbox"/> Silt	Consult a soil specialist if you have any further questions.
Are there any qualities of my soil that need special attention?	Part 1 Page 13	<input type="checkbox"/> Yes <input type="checkbox"/> No	For example, sandy profiles do not retain as much water as a clay loam. Silty soil is prone to compaction.
What is the depth of my topsoil?	Part 1 Page 14	The depth of my topsoil is: <input type="checkbox"/> 0 – 100 mm (too shallow) <input type="checkbox"/> 101 – 200 mm (average) <input type="checkbox"/> 201 – 300 mm (good) <input type="checkbox"/> > 300 mm (great)	Turf growing on less than 130 mm of topsoil will struggle to maintain coverage. There can be a number of different topsoil depths across your field. If your topsoil is too shallow, an option could be to top-dress regularly with suitable material to increase depth over time (however you need to consider other aspects such as slope, surface level, drainage, soil type, etc.)

Open space turf area	BPGs reference	Things to consider	Notes
Are there any surface undulations?		<input type="checkbox"/> Yes <input type="checkbox"/> No	<p>If yes, there could be a number of causes of surface undulations at your sports field. These could include soil quality, turf issues, traffic loads and drainage issues. Investigate what is causing the undulation and deal with this problem first.</p> <p>Consider adding topsoil to build up any depressions.</p>
What is the Readily Available Water (RAW) of my soil?	Part 1 Table 3 Page 17	Calculations:	<p>RAW is influenced by soil texture (which can vary at different topsoil levels, and whether your soil is compacted). If you have difficulty calculating the RAW of your soil, consult an expert.</p> <p>RAW can influence the irrigation requirements of your soil, such as timing and frequency.</p>
What is the infiltration rate of the soil?	Part 1 Table 4 Page 17	Calculations:	<p>Compacted soil, thick turf thatch, impermeable soil layers and increased slopes all reduce infiltration rate.</p> <p>Possible infiltration problems may be apparent if there are ponds of water on the surface after rain or irrigation.</p> <p>Infiltration rate can influence how soon you can return to play after rain.</p>
Is the soil waterlogged or saturated?	Part 1 Page 17	<input type="checkbox"/> Yes <input type="checkbox"/> No	<p>You may observe ponding after rain or irrigation, excess water on the playing surface, or the soil taking a long time to dry after rain or irrigation.</p>

Open space turf area	BPGs reference	Things to consider	Notes
Is the soil compacted?	Part 1 Page 18 (How easy is it to push a shovel into the ground?)	<input type="checkbox"/> Yes <input type="checkbox"/> No	If yes, you need to determine a suitable decompaction technique. Compaction can also be more observable in high traffic areas, such as goalmouths.
Is there any soil layering present?	Part 1 Page 18 (Dig up a section of soil. Does it look like Figure 9?)	<input type="checkbox"/> Yes <input type="checkbox"/> No	If yes, layering can limit water movement through the soil profile. You need to determine a suitable decompaction and aeration technique.
Are there any signs of water repellence in the soil?	Part 1 Pages 24–25 Table 6 – droplet test Figure 12 – what water repellence looks like	<input type="checkbox"/> Yes <input type="checkbox"/> No	If yes, you may have to resort to a wetting agent. However, prevention is better than cure. Look to page 25 for ways to overcome water repellence.
Other soil issues to look out for	Part 1 Table 7 Page 26	<input type="checkbox"/> acid sulphate soil <input type="checkbox"/> saline soil <input type="checkbox"/> sodic soil <input type="checkbox"/> saline-sodic soil <input type="checkbox"/> contaminated soil	If yes, consult a soil specialist to determine a suitable course of action.
Do you aerate and decompact your soil regularly?	Part 1 Table 5 Pages 20–21	<input type="checkbox"/> deep slitting / knifing <input type="checkbox"/> deep slicing / earthquaking <input type="checkbox"/> hollow tined corer <input type="checkbox"/> solid tine forking <input type="checkbox"/> vibrating tines / knives <input type="checkbox"/> recycling top-dresser	Different techniques suit different soil conditions. It can be beneficial to alternate techniques and ensure that appropriate depths are reached. Sites that are susceptible to compaction should be aerated more frequently.

Open space turf area	BPGs reference	Things to consider	Notes
Turf			
What are the turf species present on my sports field?	Part 2 Table 8 Page 31	<input type="text"/> % Couch <input type="text"/> % Kikuyu <input type="text"/> % Ryegrass <input type="text"/> % Other	Different turfgrasses have different requirements. Regardless of the turf type, managers should focus on achieving a good turf coverage that is free from weeds, pests and disease.
Are there any bare patches of turf?	Part 2	<input type="checkbox"/> Yes <input type="checkbox"/> No	If yes, a low cover of turf can mean something is wrong. Consider options that will encourage hardy turf, rather than re-turfing. Address the underlying problem causing bare patches, eg compaction, excessive traffic, waterlogging around sunken sprinkler heads, etc.
Any signs of moisture stress?	Part 2 Figure 14 Page 33	<input type="checkbox"/> Yes <input type="checkbox"/> No	If yes, check that your irrigation system is operating effectively. A poorly performing system may lead to moisture stress in areas of your field. If your irrigation system is operating effectively, consider your irrigation schedule. Some managers adapt their irrigation schedule to desired turf performance, eg to decrease the need for mowing.
Are there any microclimates that could affect the turf growth on my sports field?	Part 2 Pages 33–37	<input type="checkbox"/> sunlight <input type="checkbox"/> shade <input type="checkbox"/> trees <input type="checkbox"/> buildings <input type="checkbox"/> N/A	<p>If you have a microclimate affecting turf growth, consider using alternatives to turf.</p> <p>You could also try measures such as root trimming, or selecting a turf species more tolerant to shade.</p>
Do I know the fertility of my soil and turf?	Part 2 Page 38	<input type="checkbox"/> Yes <input type="checkbox"/> No	<p>If no, consider both soil and foliar testing, or speak to an expert.</p> <p>Some nutrient deficiencies can be detected by visual symptoms, eg turf growing in nitrogen-deficient soil may have small patches of healthy growth from dog urine.</p>

Open space turf area	BPGs reference	Things to consider	Notes
Is the soil prone to leaching?	Part 2 Page 38	<input type="checkbox"/> Yes <input type="checkbox"/> No	If yes, nutrients can be lost from the soil. Consider an appropriate fertilising regime, and speak to an expert.
Are your lawn clippings removed from site?	Part 2 Page 48	<input type="checkbox"/> Yes <input type="checkbox"/> No	If yes, no nutrient recycling is occurring. Lawn clippings build up the organic content and add nitrogen to your soil. Some managers choose to remove lawn clippings to reduce thatch build up, or for aesthetic reasons.
Is rapid regrowth of turf required (ie heavy traffic areas)?	Part 2 Page 38	<input type="checkbox"/> Yes <input type="checkbox"/> No	If yes, your turf may require additional nutrients. Consult an expert before working out a fertilizing regime.
Are there any species of weeds present?	Part 2 Pages 43–44 Appendix A Pages 80–81	<input type="checkbox"/> Yes <input type="checkbox"/> No	If yes, it is better to encourage a healthy cover of turf before resorting to chemical or physical removal. Methods of weed control include: <ul style="list-style-type: none"> • preventing weeds from entering the site (eg having a high percentage turf cover) • containing the weed to prevent it spreading • physical control including hand-weeding, slashing, burning, mowing, grubbing, hoeing, etc • chemical control, such as pre and post-emergent herbicides.
Are there any pests apparent (eg brown patches, grubs in the soil)?	Part 2 Pages 44–46 Appendix B Page 82	<input type="checkbox"/> Yes <input type="checkbox"/> No	If yes, consult an expert to help identify and manage the pest species present.

Open space turf area	BPGs reference	Things to consider	Notes
Any turfgrass disease/s present (eg dead patches, discoloured turf)?	Part 2 Pages 46–47 Appendix C Page 83	<input type="checkbox"/> Yes <input type="checkbox"/> No	If yes, consult an expert to help identify and manage the disease.
Is there excessive thatch on site?	Part 2 Table 11 Page 48	<input type="checkbox"/> Yes <input type="checkbox"/> No	If yes, you might use the following renovation techniques: <ul style="list-style-type: none"> • scarifying • shaving or thatch mowing. To determine what technique is appropriate, consult an expert.
Will you need to replace any turf?	Part 2 Page 49	<input type="checkbox"/> Yes <input type="checkbox"/> No	If yes, consider the following methods in order of priority: <ul style="list-style-type: none"> • Using washed turf. • Sprigging, stolonising or row planting. • Growing turf in similar soil to that at the site. • Using turf from the same site (eg at the side of the field). • Ensuring that soil brought in on unwashed turf is fully incorporated after the turf is established.

Irrigation and drainage

Does your site require supplementary water other than rainfall?	Part 3 Page 52	<input type="checkbox"/> Yes <input type="checkbox"/> No	If yes, consider trying to improve the soil RAW to capture more rain. A deep uncompacted soil with a loam texture is ideal for capturing and storing water from rainfall events. If you cannot do this, consider installing an appropriate irrigation system designed by a qualified irrigation specialist.
---	-------------------	---	--

Open space turf area	BPGs reference	Things to consider	Notes
Do you have a regular irrigation assessment performed by an appropriate person?	Part 3 Page 52	<input type="checkbox"/> Yes <input type="checkbox"/> No	If no, you need to use an expert with relevant qualifications and experience to conduct a proper irrigation audit on a regular basis. Managers should also regularly inspect their irrigation systems for effective operation between audits.
Does your irrigation system have any leaks?	Part 3 Page 58 Figure 38 Page 71 – look for evidence of leaks, such as green patches, soggy or waterlogged areas	<input type="checkbox"/> Yes <input type="checkbox"/> No	If yes, you should check your water meter at the start and end of a period when the system is off to identify a base flow (for pressured irrigation systems). If the base flow is present, locate and fix the leak.
Do your sprinklers have a uniform throw?	Part 3 Page 52	<input type="checkbox"/> Yes <input type="checkbox"/> No	If no, low distribution uniformity means that more water needs to be applied to the turf, so that areas of poor coverage receive the water they require. Adjust or replace sprinklers as required.
Do you have any sunken, bent or broken sprinkler heads?	Part 3 Page 55	<input type="checkbox"/> Yes <input type="checkbox"/> No	If yes, you will need to fix the sprinkler heads to ensure uniform distribution. Make sure you replace models with equivalent models to ensure efficiency of your irrigation system.
Is your irrigation controller installed and running properly?	Part 3 Page 58	<input type="checkbox"/> Yes <input type="checkbox"/> No	If no, you need to ensure your controller is working properly to help you apply the correct amount of water to your site.
Are your sensors calibrated and working properly?	Part 3 Page 58	<input type="checkbox"/> Yes <input type="checkbox"/> No	If no, you are wasting water. Fix as required.

Open space turf area	BPGs reference	Things to consider	Notes
Is the pressure of your irrigation system suitable for the irrigation design at your site?	Part 3 Page 56 Check the pressure of your irrigation system: <ul style="list-style-type: none"> at the pumps at the water supply at sprinkler heads. Check valves are adjusted and the correct pressure is maintained.	<input type="checkbox"/> Yes <input type="checkbox"/> No	If no, consult an expert to identify the causes of inappropriate pressures.
Is your backflow prevention device properly installed?	Part 3 Page 54	<input type="checkbox"/> Yes <input type="checkbox"/> No	If no, engage a licensed plumber with backflow accreditation to inspect your device.
Is your backflow prevention device inspection certificate up-to-date?	Part 3 Page 54	<input type="checkbox"/> Yes <input type="checkbox"/> No	If no, ensure your backflow prevention device is tested each year, according to <i>AS/NZS 3500.1</i> .
Is my site subjected to tidal inundation?	Part 3 Page 60	<input type="checkbox"/> Yes <input type="checkbox"/> No	If yes, increase the height of the site and/or levee bank.
Is a shallow water table present at my site?	Part 3 Page 61	<input type="checkbox"/> Yes <input type="checkbox"/> No	If yes, consider increasing the height of the site. If appropriate, you could consider draining the water table.
Does my site experience water run-on (surface or subsurface)?	Part 3 Page 60	<input type="checkbox"/> Yes <input type="checkbox"/> No	If yes, check if your site is intended as a flood control. You can also consider using contouring and drains to limit water flow onto your site.

Open space turf area	BPGs reference	Things to consider	Notes
Are my surface grades appropriate?	Part 3 Page 61	<input type="checkbox"/> Yes <input type="checkbox"/> No	If no, ensure you have a slope of at least 1 in 100.
Do I delay irrigation events if there is rain?	Part 3 Page 60	<input type="checkbox"/> Yes <input type="checkbox"/> No	If no, you are wasting water. Try to adjust your irrigation schedule to delay irrigation events if rain occurs.
Do I consider RAW in my irrigation scheduling?	Part 3 Page 59	<input type="checkbox"/> Yes <input type="checkbox"/> No	If no, speak to an expert about adjusting your irrigation schedule.
Holistic management			
Do I monitor and record my water use?	Part 4 Page 66	<input type="checkbox"/> Yes <input type="checkbox"/> No	If no, read your meter at least daily, or install a monitoring system. Record water use patterns so you can identify any changes.
Do I benchmark my water use?	Part 4 Page 67	<input type="checkbox"/> Yes <input type="checkbox"/> No	If no, calculate how much water you use on site and compare it to Table 2. Also consider the following methods for monitoring and benchmarking water use: <ul style="list-style-type: none"> • your Sydney Water bill • manual meter reading • submeters for irrigation system • DIY monitoring (eg data loggers) • online monitoring • central control system • rain sensors • rain gauges • soil moisture sensors.
Does my meter service the irrigation system only?	Part 4 Page 67	<input type="checkbox"/> Yes <input type="checkbox"/> No	If no, install a submeter so that you know exactly how much water is used by your irrigation system.

Open space turf area	BPGs reference	Things to consider	Notes
Does my site receive excessive levels of use?	Part 4 Page 66	<input type="checkbox"/> Yes <input type="checkbox"/> No	<p>If yes, consider developing a site management plan, including:</p> <ul style="list-style-type: none"> • implementing appropriate rest periods after rainfall and after a sporting season finishes • transferring training off-site • rotating goal positions • oversowing with ryegrass over winter (although ryegrass requires much more water over summer). <p>Consider putting user limits in place to define the maximum hours of play your field can support, based on:</p> <ul style="list-style-type: none"> • soil type • rain periods • hours of use • type of activity.
Do I have a good relationship with my local sporting clubs?	Part 4 Page 66	<input type="checkbox"/> Yes <input type="checkbox"/> No	<p>If no, consider:</p> <ul style="list-style-type: none"> • establishing a grounds checklist • postponing play during wet weather • having your clubs co-fund sports field improvements • allocating and monitoring hours for each club.
Do I use my sports field as a car park?	Part 4 Page 66	<input type="checkbox"/> Yes <input type="checkbox"/> No	<p>If yes, you are damaging the turf and causing soil compaction issues. Try finding an alternative area for cars to park.</p>

Appendix F Glossary

Aeration	Improving the movement of air, water and nutrients into the soil by reducing the density of the soil via mechanical action. Specialised machines are commonly used to either cut slices, fracture, shatter or remove small cylindrical cores from the soil.
Australian Height Datum	AHD – Australian standard measurement for sea level. The Australian Height Datum (AHD) has been adopted by the National Mapping Council as the datum to which all vertical control for mapping is referenced.
Backflow	The unintended movement of water in the opposite direction to its intended flow path. To prevent backflow of polluted water into a drinking water main, Sydney Water requires that an appropriate backflow prevention device be installed. Depending on the hazard rating of the site, suitable devices could include a reduced pressure zone (RPZ) device, a registered air gap and/or a testable double check valve.
Capillary fringe	The extremely wet zone of soil directly above the water table. The capillary fringe may be thought of as an extension of the water table and is a result of capillary rise of water into the soil pores. Depending on the soil type the capillary fringe may extend from 0.3 to 2.0 metres above the water table.
Carrying capacity	A measure of the maximum traffic load (eg hours of soccer) that a site can withstand without reducing turfgrass quality. The carrying capacity varies with turfgrass species/variety, geographic location, microclimate and season.
Cation exchange capacity (CEC)	Cation exchange capacity is the total amount of positively charged ions (cations) a soil can absorb. The higher a soil's cation exchange capacity, the greater its ability to hold positively charged ions, such as calcium, magnesium, sodium, potassium and aluminium. The term effective cation exchange capacity (ECEC) is used to refer to the total milli-equivalents per 100 grams of dry soil of exchangeable calcium, magnesium, potassium and sodium in the sample.
Chlorosis	Plants with chlorosis do not produce enough chlorophyll (the green colour).
Controller	The device used to automate irrigation systems. Controllers send signals (generally electric) to solenoid valves causing them to open/close and thereby controlling when and for how long irrigation events will occur.
Compaction	The pushing together of soil particles resulting in a decrease in pore space between them.
Compost	The relatively stable substance produced from organic material that has been placed into piles and watered often, so as to accelerate decomposition. Organic materials commonly composted include garden trimmings, manures and other animal by-products.
Coring	A method of turf cultivation that involves removing small cylindrical cores from the soil profile using hollow tines.
Cultivar	A cultivated variety of plant that differs from others in the same species and retains these distinguishing features when reproduced. For example, 'Legend' and 'Conquest' are cultivars of couch (<i>Cynodon dactylon</i>).

Cultivation	See decompaction. Refer to Table 5 for list of techniques.
Crop factor	A number that estimates the amount of water a crop will require based on the amount of water that evaporates from a standardised (eg Class A) pan of water. A crop factor of 0.8, for example, indicates that evapotranspirational losses from a crop are 80% of the losses from a standardised pan of water.
Decompaction	A reduction in the bulk density of soils, generally as a result of mechanical cultivation (eg coring, slicing or forking). The terms 'decompaction' and 'aeration' are often used interchangeably.
Dethatching	The removal of thatch (layer of intermingled dead and living turf material immediately above the soil surface) usually via mechanical cultivation. Thatch can be removed manually with a rake, but dethatching is generally performed with specialised machines (eg thatch mower).
Distribution uniformity	A statistical measure of how evenly an irrigation system applies water. Uneven watering has a low distribution uniformity, while watering that is perfectly even has a distribution uniformity of 100%.
Ecotype	A genetically distinct geographic variety within a species that is closely adapted to specific environmental conditions.
Foliar analysis	Chemical analysis of the concentration of nutrients in leaves or shoots. For reliable results, sampling must be standardised and handling and storage protocols followed with care. Appropriate interpretation guidelines must be employed.
Field capacity	The amount of water remaining in the soil after it has been saturated and allowed to drain by gravity for 24 to 48 hours.
Fungus	A lower form of plant life that lacks chlorophyll and is therefore unable to produce its own food. The majority are pre-living but some are parasitic. Most turfgrass diseases are caused by fungi that parasitise grass plants.
Gypsum	A mineral, hydrated calcium sulfate, which is used as a soil conditioner and clay breaker.
Hardpan	A dense layer of soil, often impervious to water.
Hyphae	The threadlike filaments that form the vegetative part of a fungus plant.
Leaching	The removal from the soil profile of substances dissolved in the soil solution as a result of bulk flow through the soil. The leachate includes dissolved organic compounds, mineral nutrients and salt.
Microclimate	The climatic conditions in the immediate vicinity of a plant (eg level of shade and degree of wind protection).
Mites	A group of small animals (acarina) related to spiders that are important members of the soil biota. Some species are troublesome pests of plants (eg couch mites).
Mycoplasma	Bacteria without a cell wall.

Nematodes	Small (often microscopic), unsegmented roundworms with threadlike bodies. The majority are free living in the soil and play an important role in the soil's biology, but some species attack plant roots. Other species attack parasitic fungi and are therefore beneficial to turfgrasses.
NPK ratio	Fertilisers are labelled according to the percentage of the major plant nutrients they contain. This is called the NPK ratio and is typically written as N:P:K. For example, an establishment fertiliser for turf may have an NPK ratio of 10:20:0. It has a high phosphorous level relative to nitrogen and contains no potassium.
Oversowing	Sowing seed into an existing turf. Couch, for example, is commonly oversown with ryegrass to improve turf colour and performance during winter.
Pan evaporation	Pan evaporation results indicate how much water is needed by plants. Evaporation from a standardised pot of water is measured. Pan evaporation is highest on hot, windy, dry days. Pan evaporation data can be used to estimate the rate of water loss from turf (see crop factor).
Passive recreation areas	Open-space turf areas not used for formal sporting activities.
Permanent wilting point (PWP)	The water content of the soil at which the plant wilts and does not recover. If not watered, plant death is imminent. Drought resistant turf species cease growing and often suffer death when the soil water content falls below the PWP. However, the rhizomes and sometimes other plant parts become dormant and resume growth when the drought breaks.
Photosynthesis	The way plants convert sunlight and carbon dioxide to make energy to grow. Oxygen is formed as a by product of photosynthesis.
pH (soil)	The measurement of the acidity or alkalinity of a soil. A pH of 7 is neutral. Below 7 is acidic and above is alkaline.
Rain switch	A device connected to an irrigation controller that stops irrigation when a preset amount of rain occurs.
Readily available water – RAW	The amount of water that a plant can extract from the root zone without suffering stress.
Recycling top-dresser	A machine that pulls soil up from a depth of as much as 180 mm during aeration and places it on the soil surface as top-dressing.
Refill point	The water content at which the turf starts to experience moderate levels of stress. Sometimes called the recharge point. See also 'Field capacity' and 'Permanent wilting point.'
Repellency	Soils that have a fungal or fatty/waxy coating on the particles that causes them to repel water. These soils are also referred to as hydrophobic (frightened of water).
Rhizomes	A spreading stem that grows underground and produces new shoots and roots at the nodes.
Ripping	Decompaction by pulling large chisel shaped implements through the soil. Commonly used to break up subsoils.
Root zone	The portion of the soil profile occupied by plant roots.

Scarifying	Thinning the turf using a mechanical device with rotating blades that cut into the face of the turf. The operation is usually carried out in turf for the purpose of controlling thatch or grain.
Scheduling irrigation	Determining the size and frequency of irrigation events.
Shaving	Cutting and removing all thatch from the soil surface. Turfgrass recovery is achieved by regrowth from rhizomes. Not suitable for use with non-rhizomatous grasses such as ryegrass.
Shoot	The portion of the plant that is above the soil surface, ie the stem and leaves.
Slicing	A method of turf renovation where vertically rotating, flat blades slice through the turf and soil.
Slitting	The process of installing a series of thin parallel trenches that are backfilled to the soil surface with a highly permeable material, such as sand. Slitting is used to assist in drainage.
Sod	Pieces or strips of live grass, consisting of leaves, crowns, stolons, rhizomes, roots and adhering soil, which are used for vegetative planting. Commonly sold by turf farms in the form of turf rolls which are laid like carpet to create instant lawns.
Soil moisture sensor	Device used to measure the water status of the soil. Most soil sensors estimate the water content of the soil based on the soil's electrical properties (eg electrical conductivity or conductivity). Sensors that measure the degree of effort needed to draw water from the soil (eg gypsum block) are available, though less commonly used in turf. Most sensors can be connected to an irrigation controller in order to assist in more accurate irrigation scheduling.
Soil profile	A vertical cut through the soil extending into the underlying parent material (eg rock), so that all the soil layers/horizons can be seen.
Soil structure	Refers to how the soil particles are grouped together. Sandy soils in which the sand grains remain separate are said to be structureless. When soil particles are well aggregated the soil has a crumbly structure. If the particles bind together into large blocks with minimal cracking, the soil structure is described as massive.
Soil texture	Soil texture is determined by the relative proportions of sand, silt and clay within the soil. Soil scientists use a range of textural classes to describe soils (eg sandy loam, silty clay). The relative portions of sand, silt and clay in these named textural classes can be ascertained from a texture triangle diagram in soil textbooks.
Species	A group of organisms with common characteristics and capable of interbreeding to produce fertile offspring that possess similar characteristics to the parents. Common turfgrass species in the Sydney area are buffalo, couch, kikuyu, ryegrass, fescue and bent. Each species has many cultivars (varieties) on the market.
Sprig	Stolon or rhizome used for vegetative propagating (3 – 5 cm in length).
Sodic soil	Sodic soils are characterised by a disproportionately high concentration of sodium (Na) in their cation exchange complex.

Sprigging	The vegetative establishment of turf from relatively short (3 – 5 cm) pieces of stolons and rhizomes that are planted in furrows, small holes or spread directly onto the soil surface and partly covered by lightly scarifying the area or top-dressing.
Stolon	A spreading stem that grows horizontally above the soil surface and produces new shoots and roots at the nodes (joints where buds and leaves occur).
Stolonising	Vegetative establishment by broadcasting stolons over the planting site. The stolons are covered by top-dressing or press-rolling.
Stomata	Specialised groups of cells that form pores in the leaf surface.
Syringing	A light watering lasting no longer than a few minutes, commonly used to reduce the temperature of the turf surface during periods of high evaporative demand.
Thatch	The tightly intermingled layer of dead and living stems and roots that develops between the zone of green vegetation and the soil surface.
Tillering	Growth of new side shoots from the root or bottom of the original stalk.
Tine	A prong or fork, typically used on soil aeration machines.
Top-dressing	The spreading of a thin layer of soil or compost over a turf area. Typically used to either stimulate thatch decomposition or increase surface evenness.
Topsoil (see also Soil profile)	The upper layer/s of the soil profile. In undisturbed natural soil, the topsoil generally has higher levels of organic matter and microbes and often contains less clay than deeper layers.
Traction	A measure of the amount of grip the turf surface can provide to the feet of a person, particularly important in sports that involve running.
Traffic	The movement of people, equipment, and vehicles on a turf area.
Turf	A dense covering of mowed vegetation growing in an upper soil layer containing intermingled roots, stems and bases.
Turgidity	The state of being swollen, especially due to high fluid content. Turgidity is essential in plant cells to make them keep standing upright.
Vibra spiking	A method of decompaction that involves the use of vibrating tines attached to a rotary drum. The soil is fractured to a depth of about 75 mm.
Waterlogging	When more water is added to a field than it can handle.
Water table	The top level of the saturated soil zone.
Water requirement (rain and irrigation)	The amount of water that turf requires to maintain desirable condition. Water requirements in this document have been presented in millimetres per week and vary with season. These water requirements may be met by either rainfall, irrigation or a combination of the two.
Wetting agent	A substance that reduces the surface tension of water, allowing the mixing of water with fatty/waxy substances. Wetting agents are often used to treat water repellent soils.
Wiannamatta Shale	Fine grained sedimentary rocks found in parts of Sydney, most commonly in the Cumberland Plain.

Appendix G Bibliography

- ABS, 2007. *Involvement in Organised Sport and Physical Activity, Australia*. Report No. 6285.0, Australian Bureau of Statistics. www.abs.gov.au/ausstats/abs@.nsf/mf/6285.0.
- Adams WA and Gibbs RJ (1994). *Natural Turf for Sport and Amenity*. CAB International, Wallingford.
- AIHW (2008). *Mental health services in Australia 2005–06. Mental health series No. 10*. Cat No. HSE 56. Canberra: Australian Institute of Health and Welfare.
- American College of Sports Medicine (1990). 'Position stand on the recommended quantity and quality of exercise for developing and maintaining cardio respiration and muscular fitness in healthy adults.' *Medical Science Sports Exerpt* 22: 265–74.
- Attanake S (1995). 'Differences in Adaption to Cool Temperatures Between Two Couch Cultivars.' M.Agr. Thesis, University of Sydney.
- Atwell B, Kriedemann P and Turnbull C (1999). *Plants in action: adaptation in nature, performance in cultivation*. The Australia Society of Plant Physiologists, the New Zealand Society of Plant Physiologists and the New Zealand Society for Horticultural Science.
- Auld BA, Medd RW (1992). *Weeds; An illustrated botanical guide to the weeds of Australia*. Inkata Press Port Melbourne, Australia.
- Australian Pesticide and Veterinary Medicines Authority (APVMA) www.apvma.gov.au/index.asp, accessed 2009.
- Australian Standards (2003). AS 4454: Compost, soil conditioners and mulches*.
- Australian Weeds Committee, Weeds Australia website, www.weeds.org.au, accessed 2009.
- Bailey G (2009). *South Australian Stock Journal*, 30 April 2009.
- Bardgett R (2005). *The biology of soil: a community and ecosystem approach*. Oxford University Press, Oxford.
- Battam MA (1998). 'Minimising Deep Drainage Loss from Subsurface Drip Irrigation.' PhD Thesis, The University of Sydney.
- Battam M, Boughton D and Sutton B (2001). 'Drip irrigation: the effect of soil type.' *The Australian Cotton Grower*, Jan/Feb: 58–63.
- Battam MA and Sutton BG (2001). *Agri-Systems Management and Irrigation Science: Practical Manual*. The University of Sydney.
- Battam M, Boughton D, Hulme P and Sutton B (2002). 'Drip irrigated cotton observing wetting patterns.' *Water and Irrigation International* 22(1): 27–29.
- Battam M, Robinson S and Sutton B (2002). 'Choosing an emitter application rate for subsurface drip emitters.' Australian Conference on Engineering in Agriculture. Wagga Wagga. Agricultural Engineering, Charles Sturt University.
- Beard JB (1973). *Turfgrass: Science and Culture*. Prentice-Hall Inc., Englewood Cliffs, NJ.
- Beard JB (1985). 'An assessment of water use by turfgrasses.' *Turfgrass Water Conservation* (Eds. V Gibeault and S Cockerham). pp. 45–59. Division of Agriculture and Natural Resources, The University of California.
- Beard JB (1989). 'Turfgrass water stress: Drought resistance components, physiological mechanisms, and species-genotype diversity' pp. 23–28. In H. Takatoh (ed.) Proc. 6th Int. Turfgrass Research Conference, Tokyo. July 1989. Japanese Society of Turfgrass Science, Tokyo.
- Beard JB (1997). 'Shade stresses and adaption mechanisms of turfgrasses.' *International Turfgrass Society Research Journal* 8: 1186–1195.
- Beard J and Beard H (2005). *Beard's Turfgrass Encyclopaedia for Golf Course, Grounds, Lawns and Sports Fields*. Michigan State University Press, East Lansing.

- Beard JB and Green R (1994). 'The role of turfgrasses in environmental protection and their benefits to humans.' *Journal of Environmental Quality* 23: 452 – 460.
- Brady NC and Weil RR (2002). *The nature and properties of soils* (13th Edition). Prentice Hall. New Jersey.
- Bregar MJ, and Moyer WW (1990). 'An automated system for field testing and soil impact analysis.' *Natural and Artificial Playing Fields: Characteristics and Safety Features*. Ann Arbor, MI: American Society for Testing and Materials.
- Canaway PM, Bell MJ, Holmes G and Baker SW (1990). 'Standards for the playing quality of natural turf for Association Football.' *Natural and Artificial Playing Fields* (Ed. R Schmidt). American Society for Testing Materials (ASTM International).
- Carrow R and Petrovic A (1992). 'Effects of Traffic on Turfgrass.' *Turfgrass* (Eds D Waddington, R Carrow and R Shearman) pp. 285 – 330. American Society of Agronomy: Madison, Wisconsin, USA.
- Collis-George N (1988). 'The physical properties of soils.' *The Scientific Basis of Modern Agriculture* (Eds. K Campbell and J Bower) pp. 25 – 53. Sydney University Press.
- Committee on the Uniformity of Plumbing and Drainage Regulations in NSW (2006). *New South Wales Code of Practice: Plumbing and Drainage*. NSW Department of Energy, Utilities and Sustainability, Sydney.
- Commonwealth of Australia (2010). *Australia to 2050: Future Challenges*. Commonwealth of Australia, Barton ACT.
- Cooper R (1995). 'Seasonal oversowing of couchgrass with perennial ryegrass.' Proceedings of the 2nd ATRI Turf Research Conference. Australian Turfgrass Research Institute, Concord West.
- Craze B and Hamilton GJ as cited by Hazelton PA and Murphy BW ed. (1992). *What do all the numbers mean? A guide for the interpretation of soil test results*. Department of Conservation and Land Management, Sydney.
- CSIRO Entomology www.ento.csiro.au/aicn/index.htm (accessed 2009).
- DEC (2004). *Use of Effluent by Irrigation, Environmental Guidelines*. Department of Environment and Conservation, Sydney.
- DECC (2006). *Managing Urban Stormwater: Harvesting and Reuse*. Department of Environment and Climate Change, Parramatta.
- DECC (2006). *Summary of Climate Change Impacts: Sydney Region. NSW Climate Change Action Plan*. Department of Environment and Climate Change, Parramatta.
- DECC (2007). *Using compost materials on council sports fields*. Department of Environment and Climate Change, Sydney South.
- DECC (2008). *Summary of Climate Change Impacts, Sydney Region. NSW Climate Change Action Plan*. Department of Environment and Climate Change, Sydney South.
- Department of Health and the Ageing (2008). *Sport*. www.health.gov.au.
- De Ridder N and Boonstra J (1994). 'Analysis of water balances.' *Drainage principles and applications* (Ed. H Ritzema) ILRI Publication 16 (2nd ed.). ILRI, Wageningen, The Netherlands.
- De Vries S, Verheij RA, Groenewegen PP and Spreeuwenberg P (2003). 'Natural environments – healthy environments? An exploratory analysis of the relationship between green space and health.' *Environment and Planning* 35: 1717 – 1731.
- Dudeck AE and Peacock CH (1992). 'Shade and Turfgrass Culture.' *Turfgrass* (Eds DV Waddington, RN Carrow and RC Shearman) pp. 269 – 284. American Society of Agronomy: Madison, Wisconsin, USA.

- Emmons R (1999). *Turfgrass Science and Management*. Demar Cengage Learning, New York.
- Farley T and Ferris D (1998). 'Biomechanics of walking and running: centre of mass movements to action.' *Exercise and Sport Sciences Reviews* 26: 253 – 285.
- Fermanian TW, Shurtleff MC, Randell R, Wilkinson HT, Nixon PL (1997). *Controlling Turfgrass Pests*. Prentice Hall: New Jersey, USA.
- Fitzpatrick E and Nix H (1969). 'A model for simulating soil water regime in alternating fallow-crop systems.' *Agricultural Meteorology* 6: 303 – 307.
- Fitzpatrick E and Nix H (1970). 'The climatic factor in Australian grassland ecology.' *Australian Grasslands* (Ed. R M Moore). ANU Press, Canberra.
- Fulkerson B (2007). 'Kikuyu Grass. Technical Note. Future Dairy Project', Dairy Research and Development Corporation, Australia.
- Gibbs RJ, Adams WA and Baker SW (1993). 'Playing quality, performance, and cost-effectiveness of soccer pitches in the UK'. *International Turfgrass Society Research Journal* 7: 212 – 221.
- Gidlof-Gunnarsson A, Ohrstrom E (2007). 'Noise and well-being in urban residential environments: The potential role of perceived availability to nearby green areas', *Landscape and Urban Planning*, 83: 115 – 126.
- Groves R, Boden R and Lonsdale W (2005). *Jumping the fence: Invasive garden plants in Australia and their environmental and agricultural impacts*. CSIRO, Ultimo.
- Handreck K and Black N (2002). *Growing media for ornamental plants and turf*. Third Edition. University of NSW Press, Sydney.
- Hanna W, Chaparro C, Mathews B, Burns J, Sollenberger L and Carpenter J (2004). 'Perennial Pennisetums'. In: 'Warm-Season (C4) Grasses' (Eds. L Al-Amoodi, K Barbarick, C Roberts, W Dick, L Moser, B Burson and L Sollenberger) pp. 503 – 531. *Agronomy* No. 45. American Society of Agronomy, Madison, Wisconsin USA.
- Harivandi A, Davis W, Gibeault V, Henry M, Van Dam J and Wu L (1984). 'Selecting the best turfgrass'. *California Turfgrass Culture* 34(4): 17 – 18.
- Harris JN, New PB and Martin PM (2006). 'Laboratory tests can predict beneficial effects of phosphate solubilising bacteria on plants'. *Soil Biology and Biochemistry* 38: 1521 – 1526.
- Hazelton PA and Murphy BW (2007). *Interpreting soil test results: what do all the numbers mean?* 2nd Edition. CSIRO Publishing.
- Hillel D (1982). *Introduction to Soil Physics*. Academic Press Inc., New York, USA.
- Horticulture Australia, 2009. The Australian Turf Industry. www.horticulture.com.au/librarymanager/libs/138/Turf_Industry_Strategic_Plans_08.pdf.
- Hull JD (2005). 'Factors Affecting Critical Soil and Tissue Phosphorus Levels in Bent and Couch Turf'. PhD Thesis, The University of Sydney.
- ICA Coaching (2009). *Exercise Energy Charts*. ICA Coaching Website (www.soccerclinics.com).
- Ivory D and Whiteman P (1978). 'Effect of temperature on growth of five subtropical grasses. Effect of day and night temperature on growth and morphological development'. *Australian Journal of Plant Physiology* 5: 131 – 148.
- Jim CY and Chen WY, (2006). 'Impacts of urban environmental elements on residential housing prices in Guangzhou (China)'. *Landscape and Urban Planning* 78: 422 – 434.
- King G (1988). 'Pasture production.' *The Scientific Basis of Modern Agriculture* (Eds. K Campbell and J Bower) pp. 186 – 207. Sydney University Press.
- King PM (1981). 'Comparison of methods for measuring severity of water repellence of sandy soils and assessment of some factors that affect its measurement'. *Australian Journal of Soil Research* 19, 275 – 285

- Kneebone WR, Kopec DM and Mancino CF (1992). 'Water Requirements and Irrigation'. *Turfgrass* (Eds DV Waddington, RN Carrow and RC Shearman) pp. 441 – 472. (American Society of Agronomy: Madison, Wisconsin, USA).
- Koppi AJ (1988). 'Pedology and Land Use,' *The Scientific Basis of Modern Agriculture* (Eds. KO Campbell and JW Bower). pp. 79 – 108. Sydney University Press.
- Kuo F and Sullivan WC (2001). 'Environment and crime in the inner city: does vegetation reduce crime?' *Environment and Behaviour* 33: 343 – 367.
- Loch D (2006). 'Amenity grasses for salt-affected parkland in coastal Australia'. Horticulture Australia Limited Project TU02005.
- McCarty LB (2003). *Fundamentals of turfgrass and agricultural chemistry*. John Wiley & Sons, Hoboken, New Jersey.
- McIntyre K and Jakobsen B (1992). 'Achieving water conservations through smart system management'. Conference Proceedings of the National Irrigation Convention. Irrigation Association of Australia, Hornsby.
- McIntyre K and Jakobsen B (1998). *Drainage for Sports Turf and Horticulture*. Horticultural Engineering Consultancy, Kambah, ACT.
- McIntyre K (2004). *Problem Solving for Golf Courses, the Landscape, Sports Grounds and Race Courses*. Horticultural Engineering Consultancy, Kambah, ACT.
- McVey G, Mayer E and Simmons J (1969). 'Responses of various turfgrasses to certain light spectra modifications'. In 'Proceedings First International Turfgrass Research Conference' pp. 264 – 272. International Turfgrass Society and Sports Turf Research Institute, Bingley, Yorkshire, England, UK.
- Maas J, Verheij RA, Groenewegen PP, de Vries S, and Spreeuwenberg P, (2006). 'Green space, urbanity, and health: how strong is the relation?' *Journal of Epidemiology and Community Health* 60: 587–592.
- Maller C, Townsend M, Brown P and St Leger L (2008). 'Healthy Parks, Healthy People: Health benefits of contact with nature in a park context – A review of current literature'. Deakin University, Parks Victoria. Melbourne, Australia. www.parkweb.vic.gov.au/resources/mhphp/pv1.pdf.
- Marshall T, Holmes J and Rose C (1996). *Soil Physics*. Third Edition. Cambridge University Press, New York, USA.
- Martin PM (2001). 'The science of thatch accumulation and breakdown'. *Golf and Sports Turf Australia*. Oct/Nov, pp. 37 – 45.
- Miller R and Donahue R (1990). *Soils: An Introduction to Soils and Plant Growth*. Sixth Edition. Prentice-Hall Inc., USA.
- Miyazaki T (1993). *Water Flow in Soils*. Marcel Dekker, Inc., New York, USA.
- Morris L, Sallybanks J and Willis K (2003). 'Sport, Physical Activity and Antisocial Behaviour in Youth'. *Research and Public Policy Series*, No. 49, Australian Institute of Criminology, Canberra, 125 pp.
- National Tidal Centre (2005). 'Australian Baseline Sea Level Monitoring Project: Sea level data summary report July 04 – Jun 05', Australian Bureau of Meteorology.
- NSW Parliament (2006). 'Inquiry into Sportsground Management'. Report 53/08. New South Wales Parliament, Legislative Assembly.
- Nus J (1994) 'After the sky has fallen: flooding tolerance'. *Golf Course Management*, June 1994 pp. 49 – 53.
- Paffenbarger R, Hyde R, Wing A and Hsieh C (1986). 'Physical activity, all-cause mortality and longevity of college alumni'. *National English Journal of Medicine* 314: 605 – 613.
- Parker J (1982). 'An energy and ecological analysis of alternate residential landscapes'. *Journal of Environmental Systems* 11: 271 – 288.

- Periera L, Raes D, Smith M (1998). 'Crop Evapotranspiration – Guidelines for Computing Crop Water Requirements'. FAO Irrigation and Drainage Paper no. 56. Food and Agriculture Organisation of the United Nations, Rome.
- Potter DA (1998). *Destructive Turfgrass Insects: Biology, Diagnosis and Control*. Ann Arbor Press: Chelsea, Michigan.
- Richardson G (1996). 'Sewer mining: an alternative water source' *Environmental Issues for Turf, a Symposium*, Australian Turfgrass Research Institute, Concord West.
- Robbins N, Shaw C, Lewis S and Whitbread C (2007). 'Nursing management of diabetes mellitus' *Lewis's Medical-Surgical Nursing: Assessment and Management of Clinical Problems* (Eds. D Brown and H Edwards). Elsevier, Australia. Second Edition.
- Seesaw (2009) *Using Body Mass Index for Age Charts: Boys*. www.seesawprojects.com.
- Shearman RC and Beard JB (1975). 'Turfgrass wear mechanisms: II. Effects of cell wall constituents on turfgrass wear tolerance'. *Agronomy Journal* 67: 211–215.
- Shearman RL (2006). 'An Investigation into the Cause of Sudden Death in Australian Citrus'. PhD Thesis. The University of Sydney.
- Short DC (2002). 'Irrigation Requirements and Water Use of Turfgrasses in a Mediterranean-Type Environment'. PhD Thesis. University of Western Australia.
- Smiley RW, Dernoeden PH, Clarke BC (2005). *Compendium of Turfgrass Diseases*, 3rd ed. The American Phytopathological Society, Minnesota, USA.
- Smith FW and Loneragan JF (1997). 'Interpretation of plant analysis: concepts and principles' *Plant analysis: an Interpretation Manual*, (Eds. D J Reuter and J B Robinson), pp. 3 – 33. CSIRO Publishing, Collingwood, Victoria. Second Edition.
- Spoor G and Leeds-Harrison P (1999). 'Nature of heavy soils and potential drainage problems' *Agronomy No. 38, Agricultural Drainage* (Eds. R Skaggs and van Schilfhaarde). American Society of Agronomy, Inc., Madison, USA.
- Sutton B (1988). 'The Growing Crop' *The Scientific Basis of Modern Agriculture* (Eds. K O Campbell and J W Bower). pp. 154 – 165. Sydney University Press.
- Sydney Water (2008). Backflow Prevention. sydneywater.com.au/Plumbing/BackflowPrevention.
- Sydney Water (2009). *Sydney Water's recycled water areas: plumbing guidelines*. sydneywater.com.au/Savingwater/Recyclingandreuse/.
- Tyrvaainen L and Miettinen A (2000). 'Property prices and urban forest amenities'. *Journal of Environmental Economics and Management* 39: 205 – 223.
- University of California, *Guide to Healthy Lawns: Identification Key*. www.ipm.ucdavis.edu/TOOLS/TURF/PESTS/weedkey.html.
- University of Michigan, *Turf Weed Identification Tool* www.msuturfweeds.net, accessed 2009.
- Urlich R (1984). 'View through a window may influence recovery from surgery'. *Science* 224: 420 – 1.
- Walker W and Skogerboe M (1987). *Surface Irrigation: Theory and Practice*. Prentice-Hall Inc., New Jersey.
- Water Services Association of Australia and Irrigation Association of Australia Ltd (2006). *Urban Irrigation: Best Management Practices*. Irrigation Association of Australia Ltd, Hornsby, Australia.
- Wilson J (1997). 'Adaptive responses of grasses to shade: relevance to turfgrasses for low light environments'. *International Turfgrass Society Research Journal* 8: 575 – 592.
- Winterbottom W (1985). *Artificial Grass Surfaces for Association Football*. Sports Council, London.
- Youngner V (1961). 'Accelerated wear tests on turfgrasses'. *Agronomy Journal* 53: 217-218.

Contact us

sydneywater.com.au

Enquiries

Call 13 20 92

Service difficulties and emergencies

Call 13 20 90

Postal address

Sydney Water

PO Box 399

Parramatta NSW 2124